

STA. 8+00

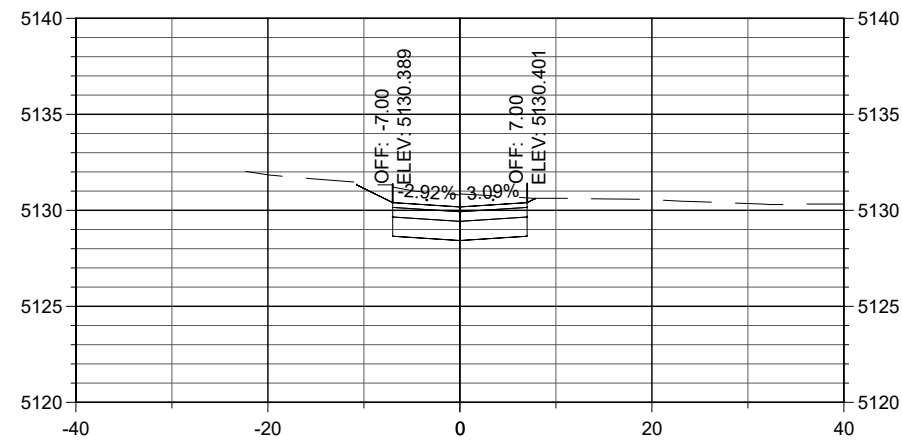

STA. 8+20

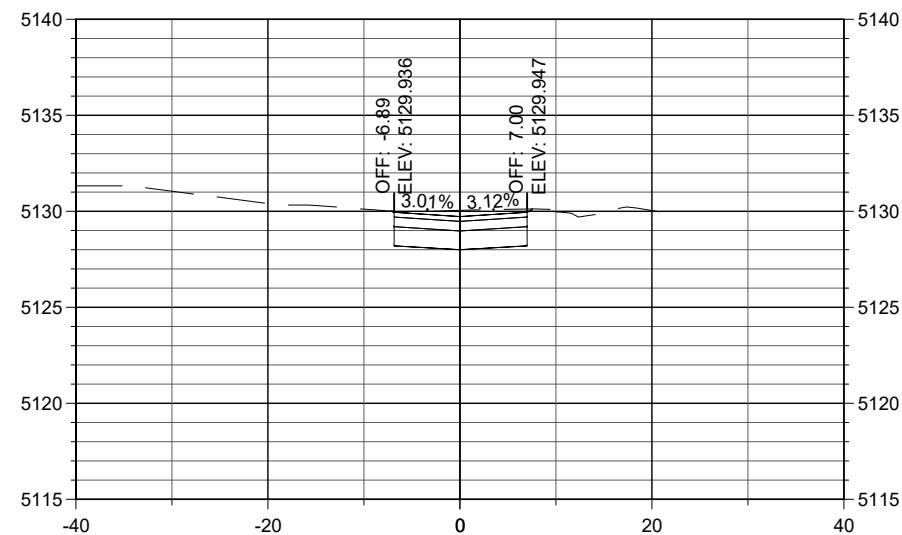

STA. 7+60

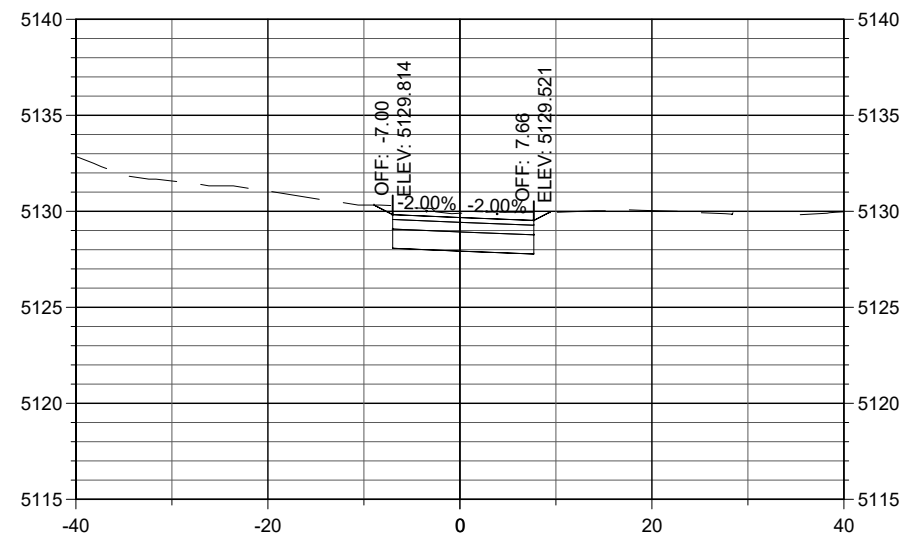

STA. 7+80

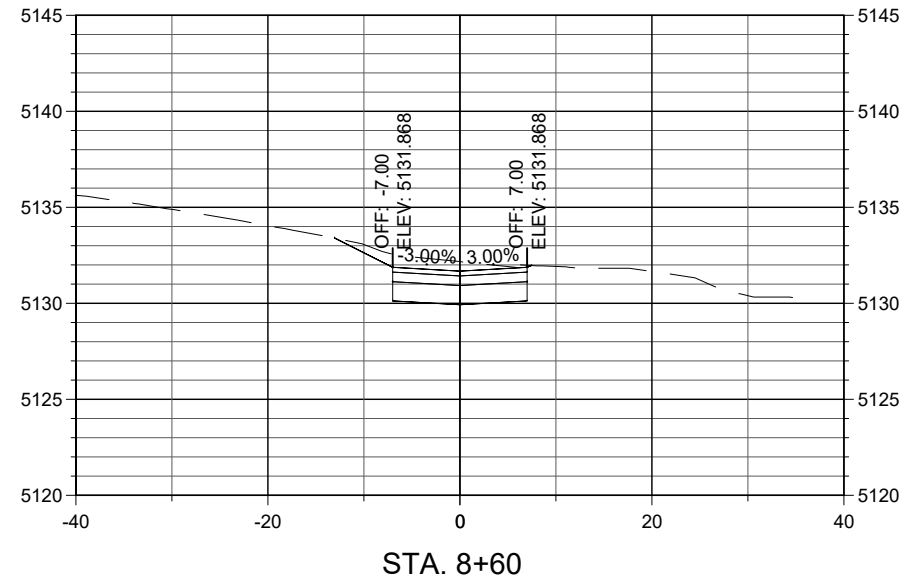
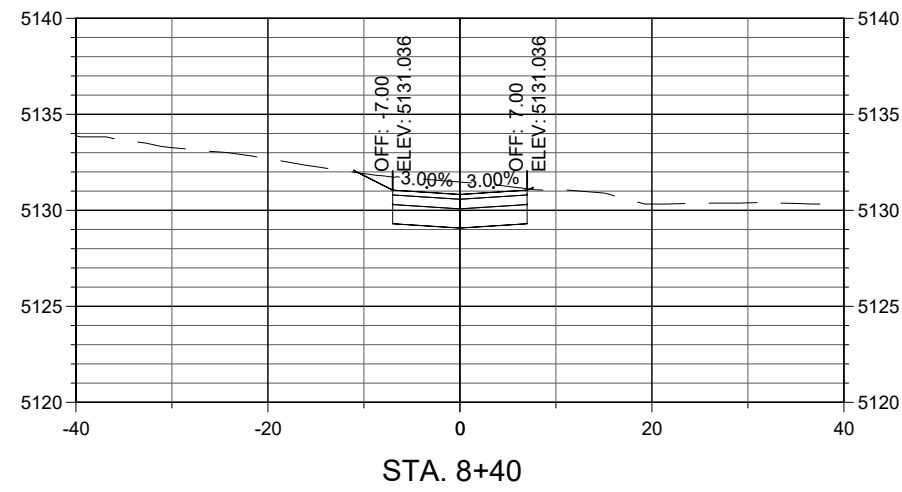
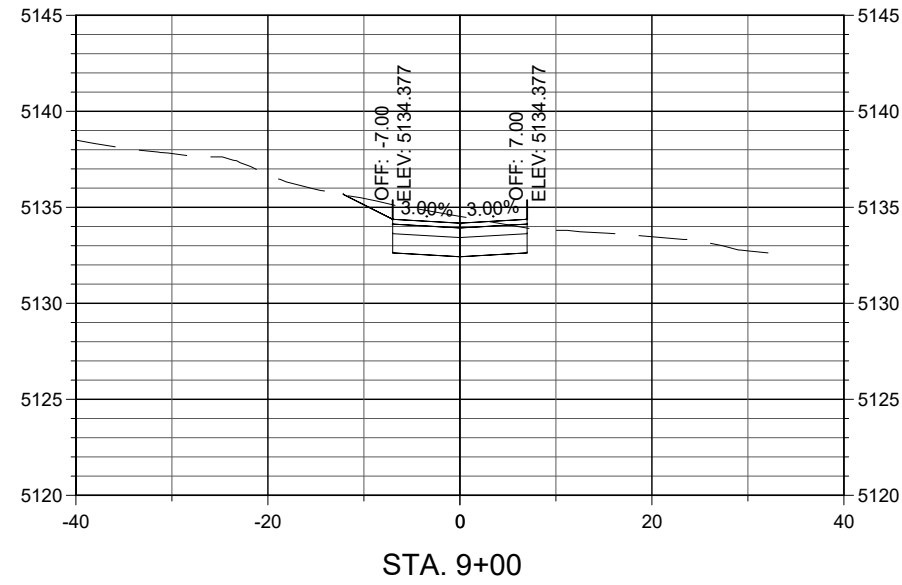
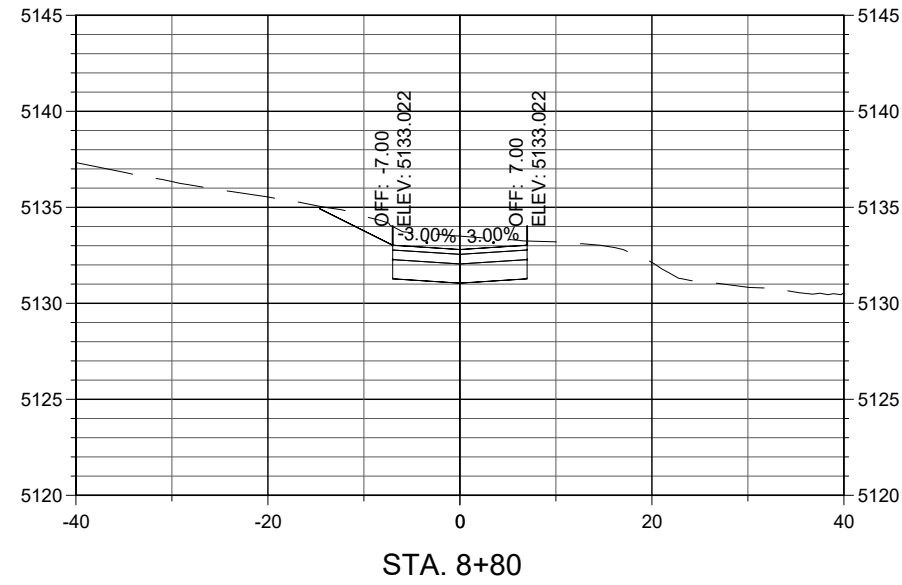

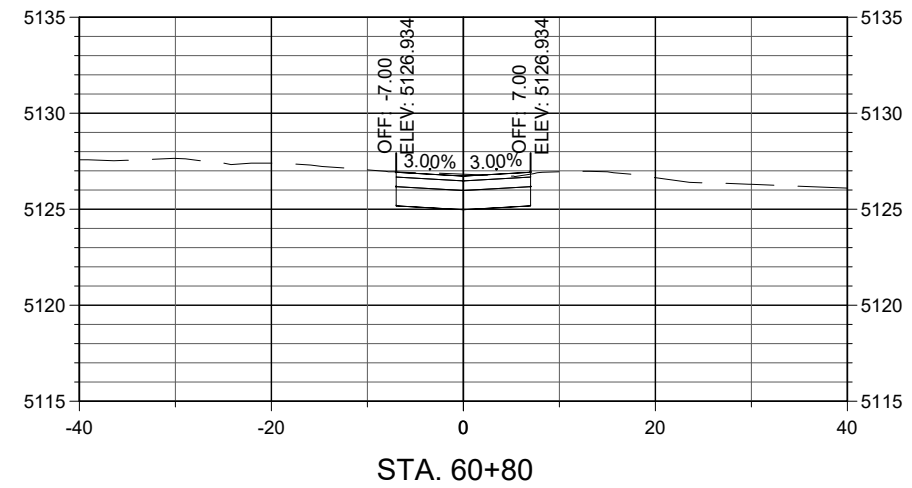
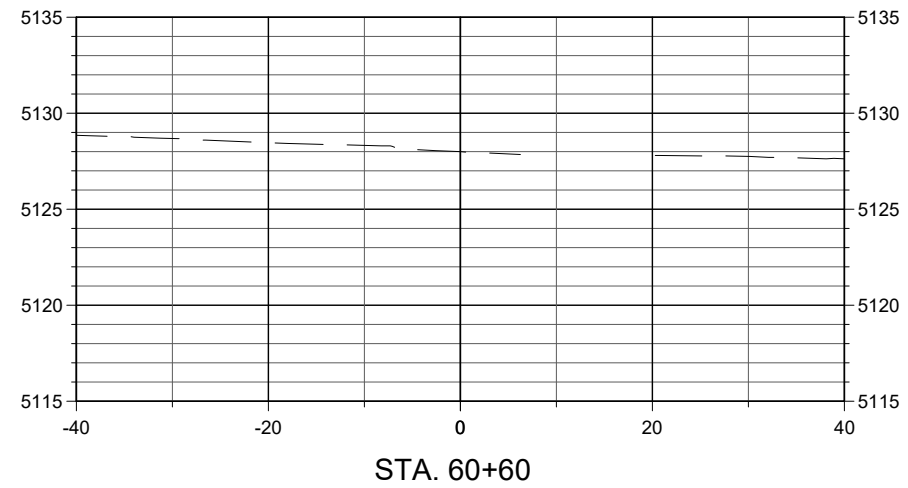
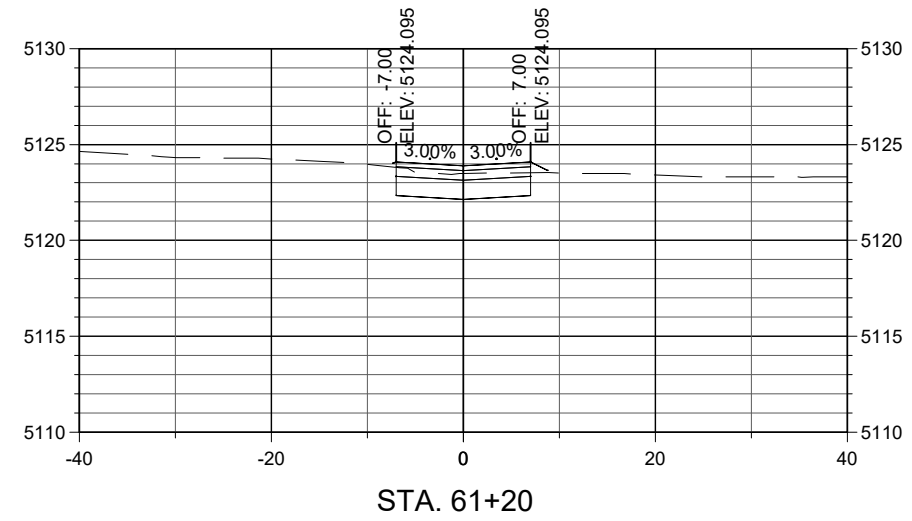
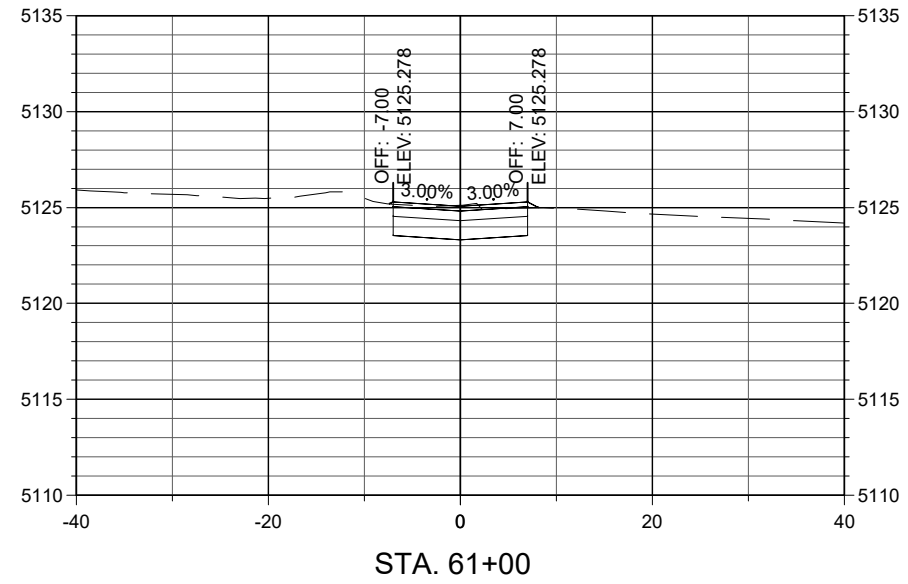



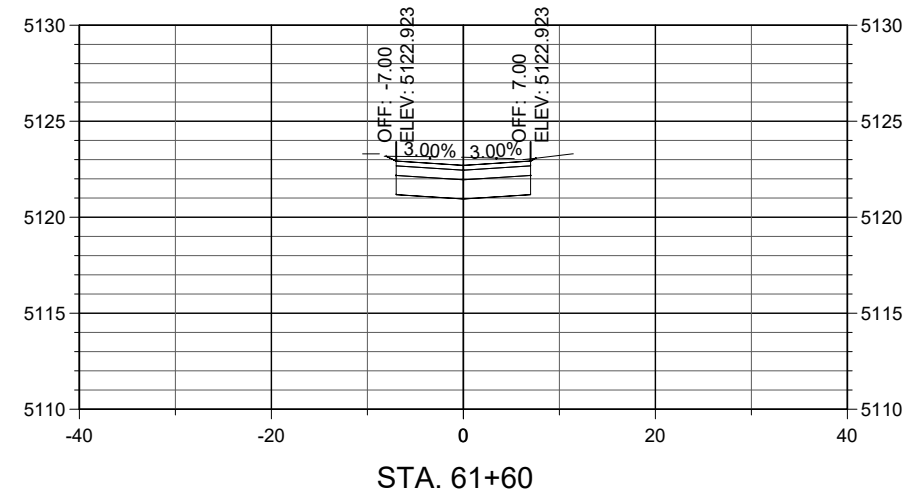
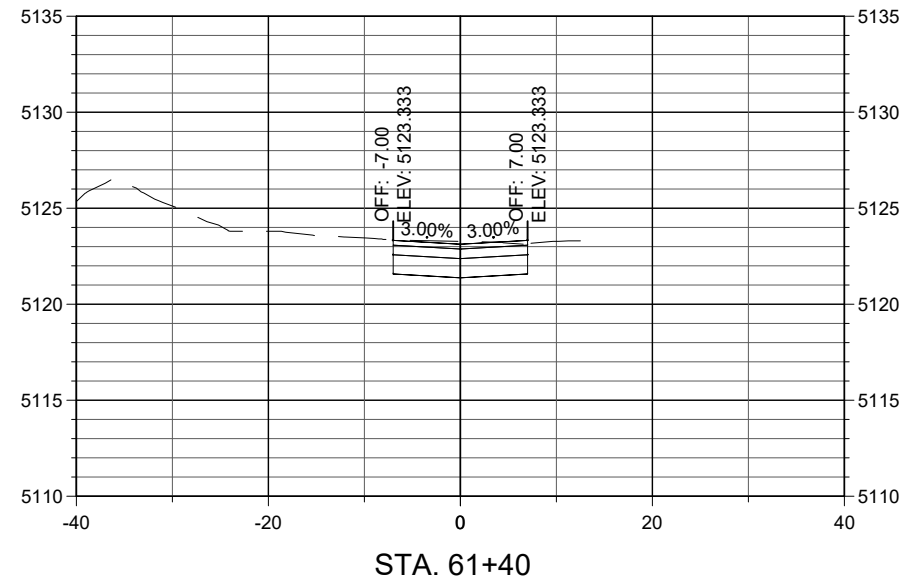
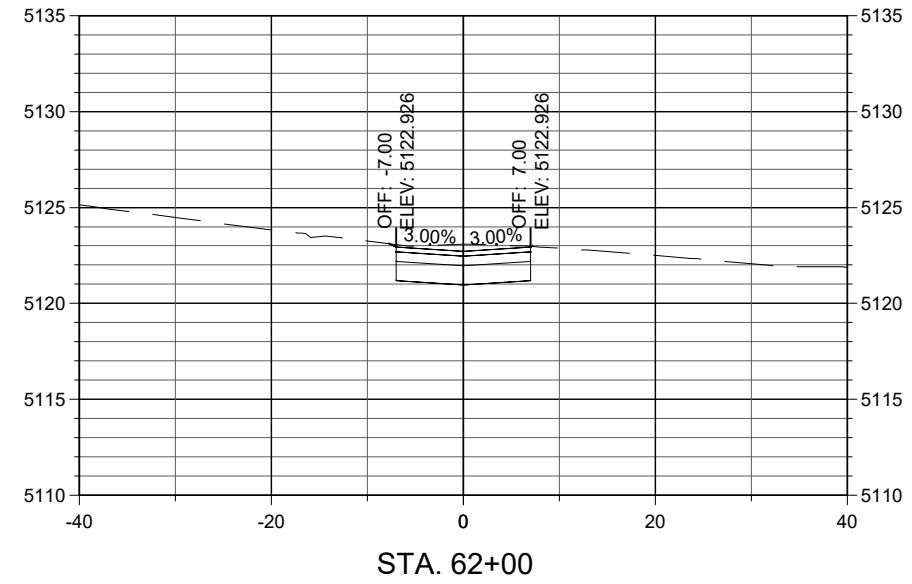
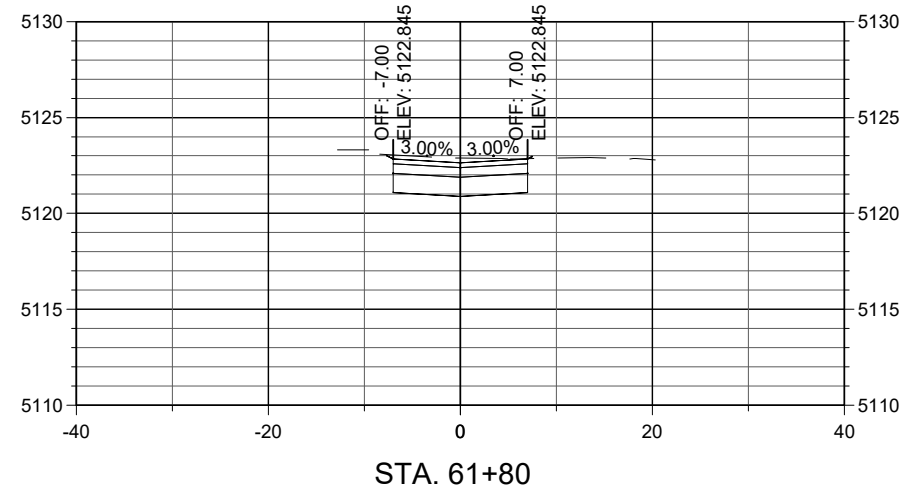

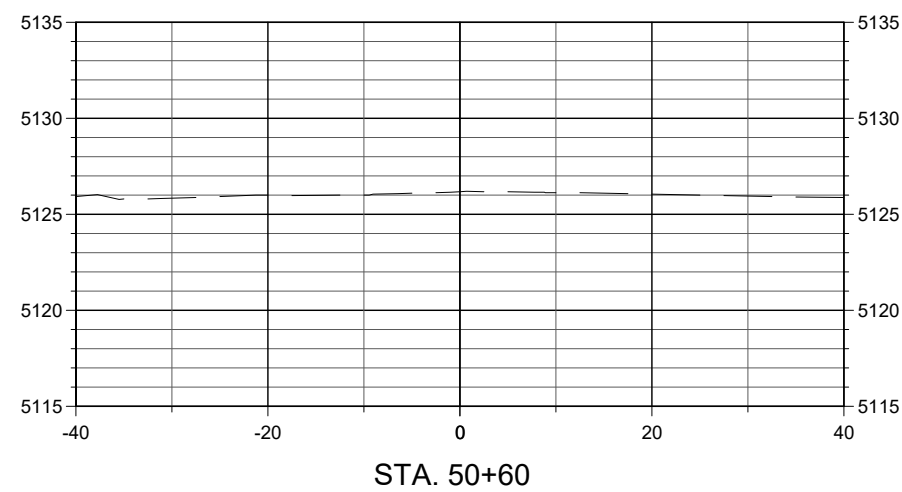
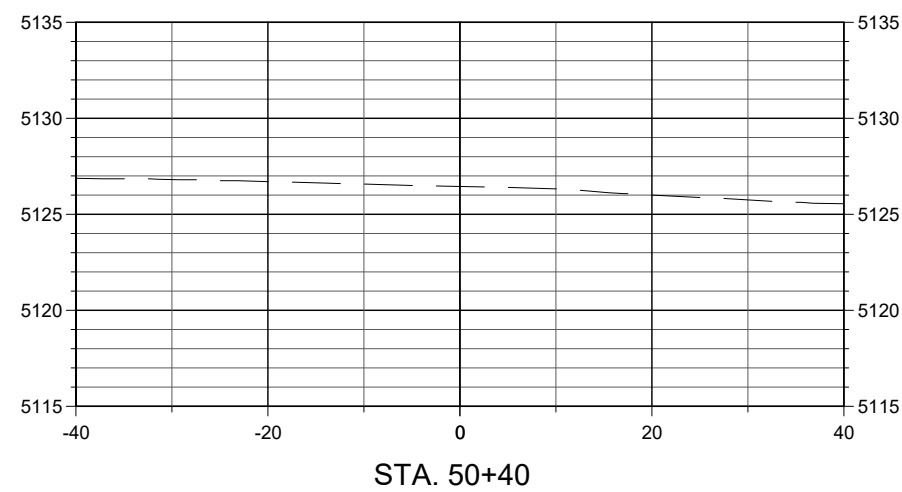
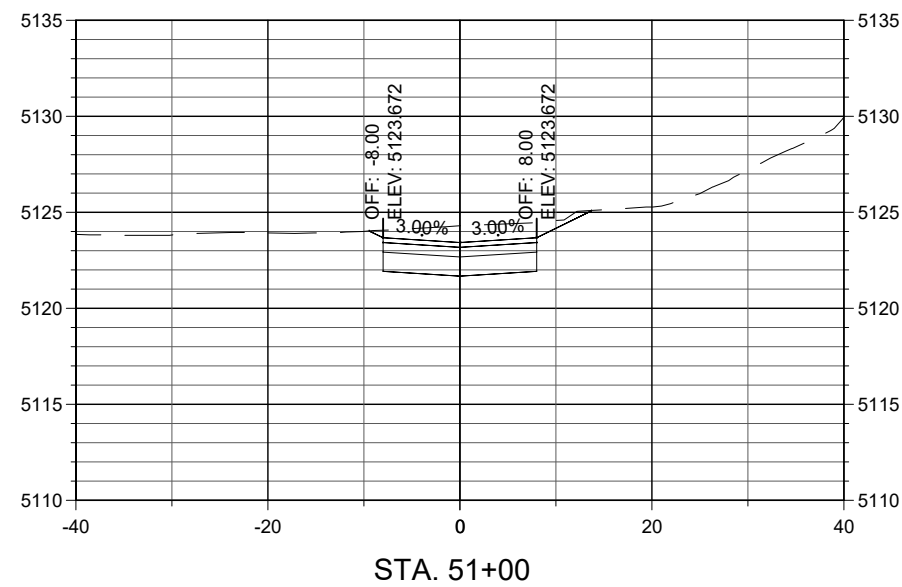
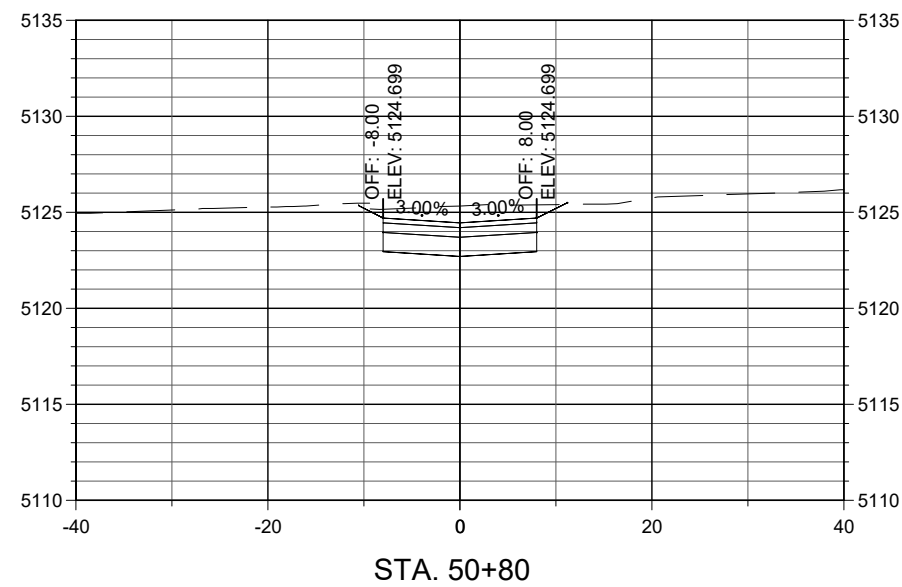

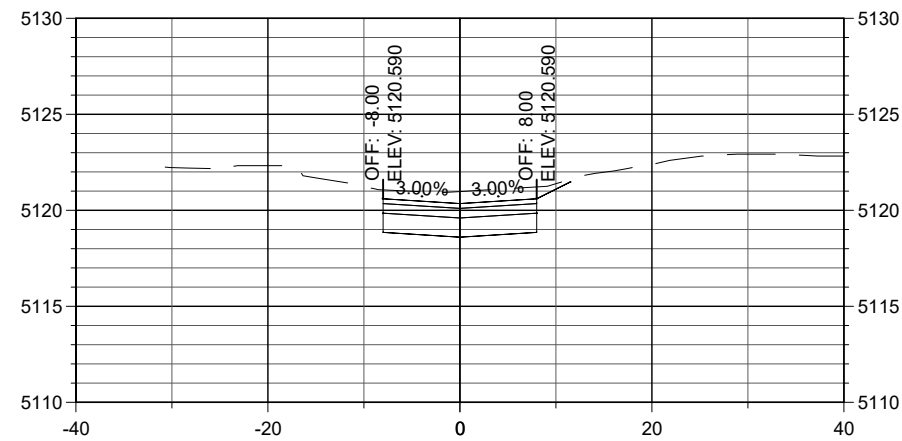

STA. 51+60

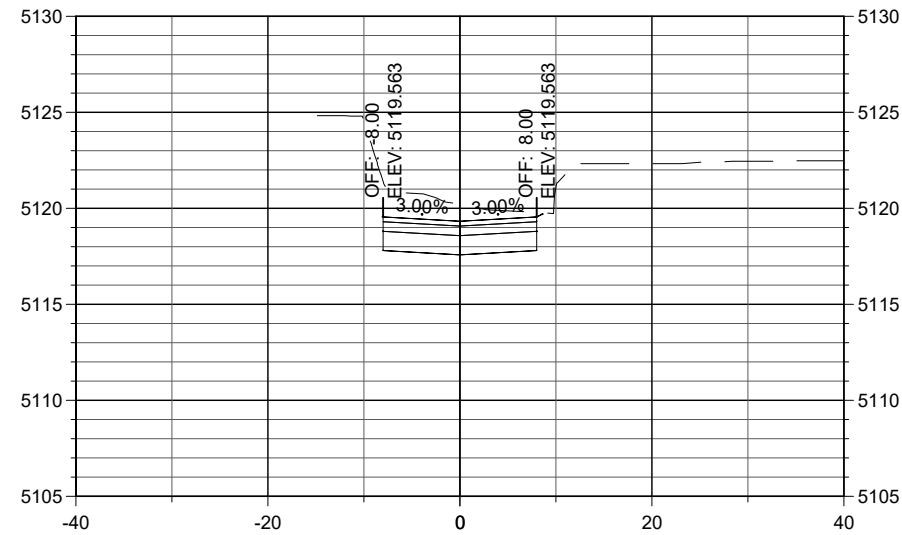

STA. 51+80

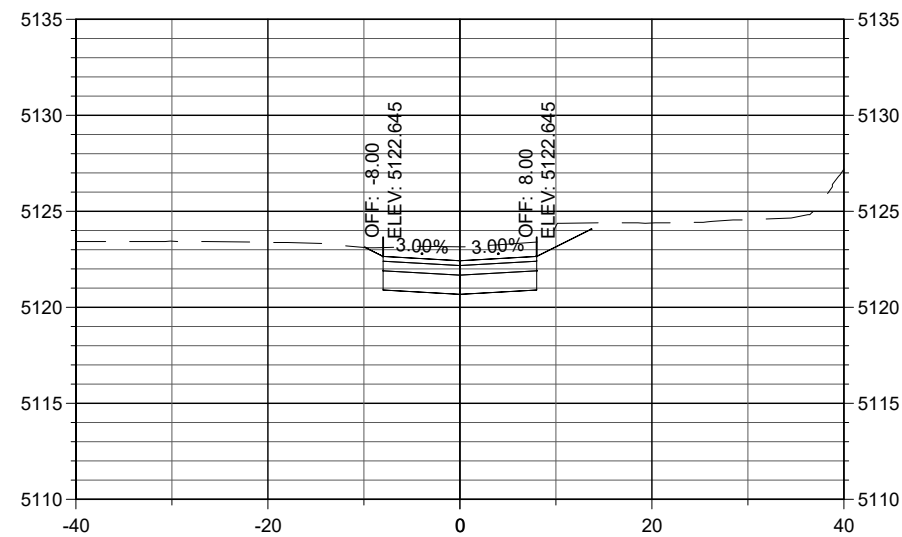

STA. 51+20

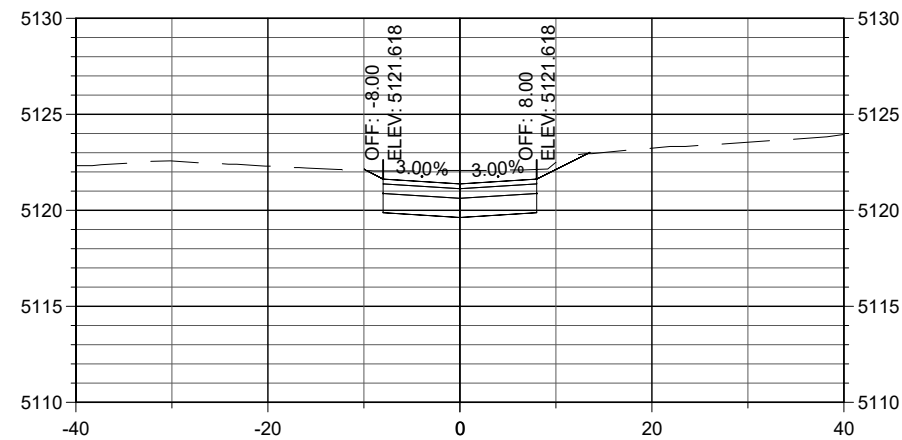

STA. 51+40

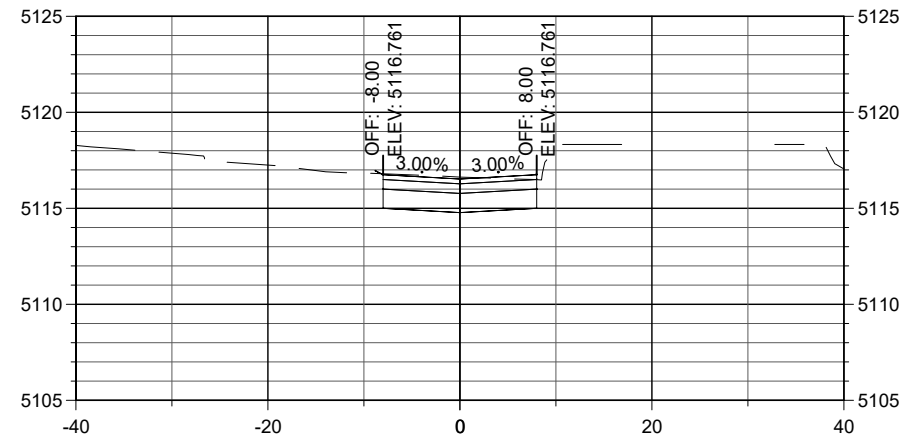

STA. 52+40

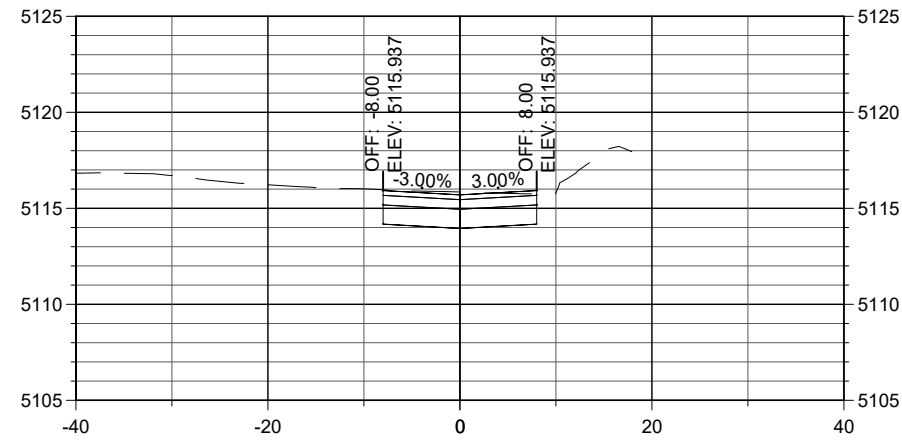

STA. 52+60

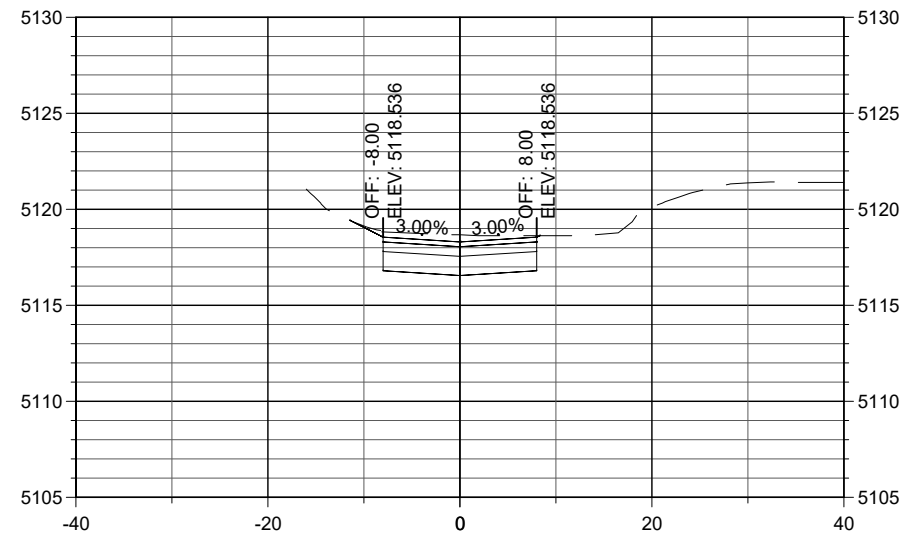

STA. 52+00

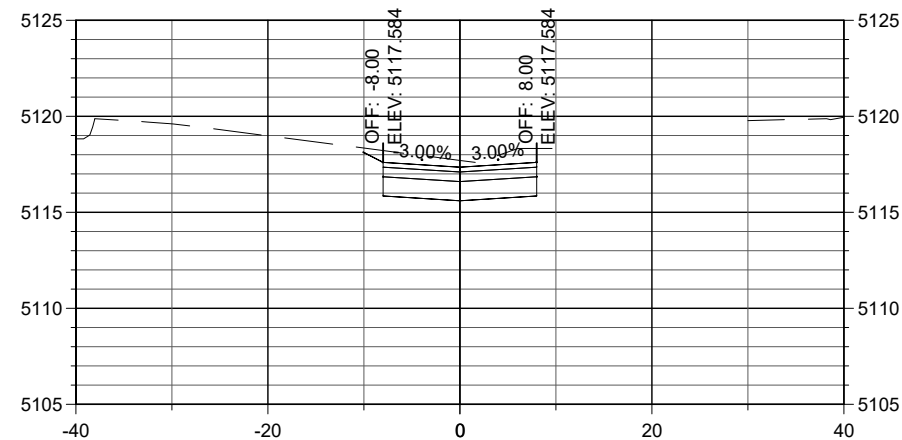

STA. 52+20

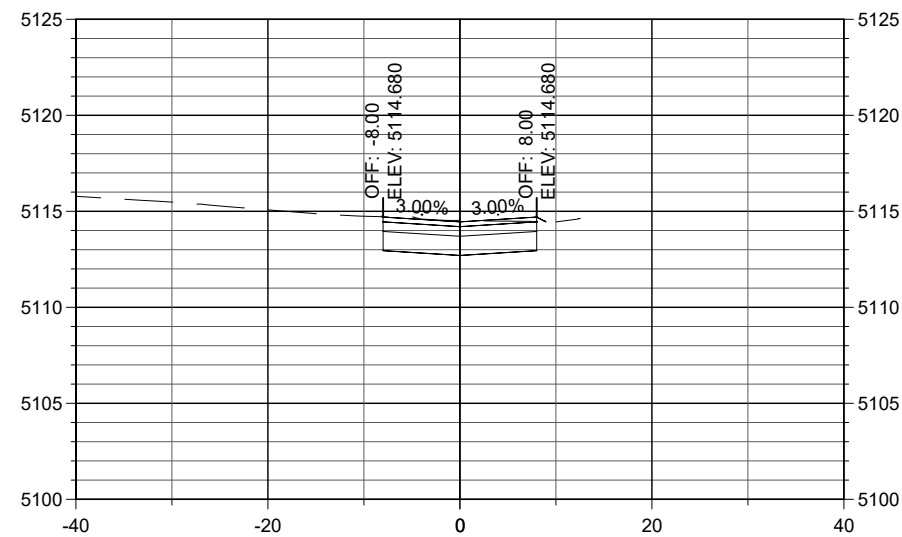
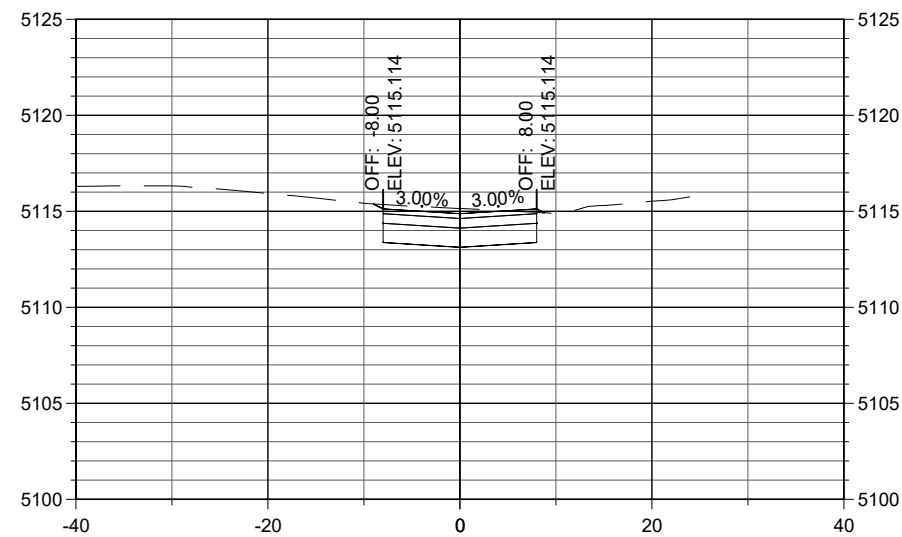
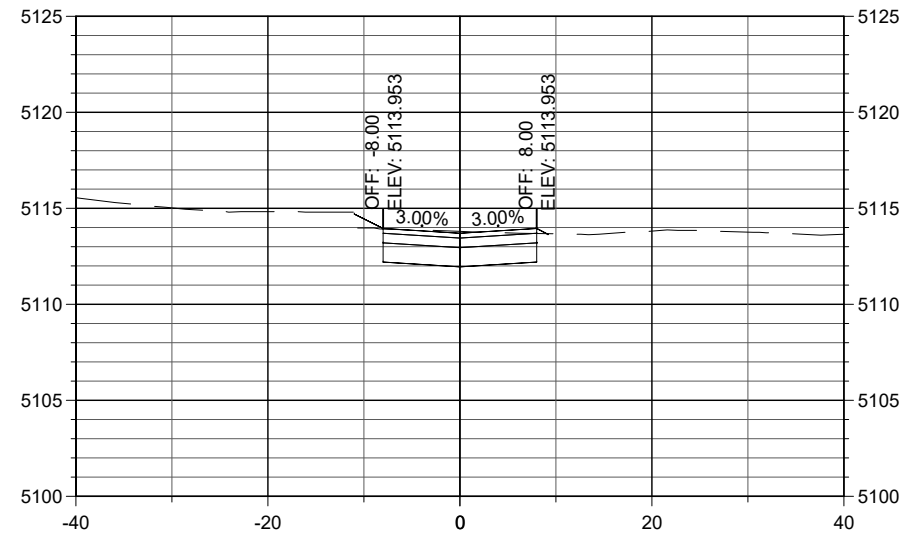
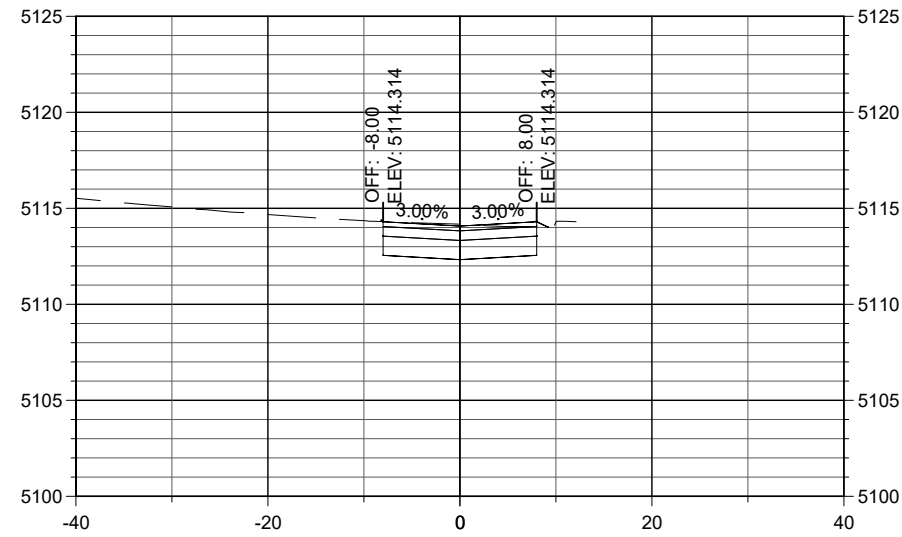

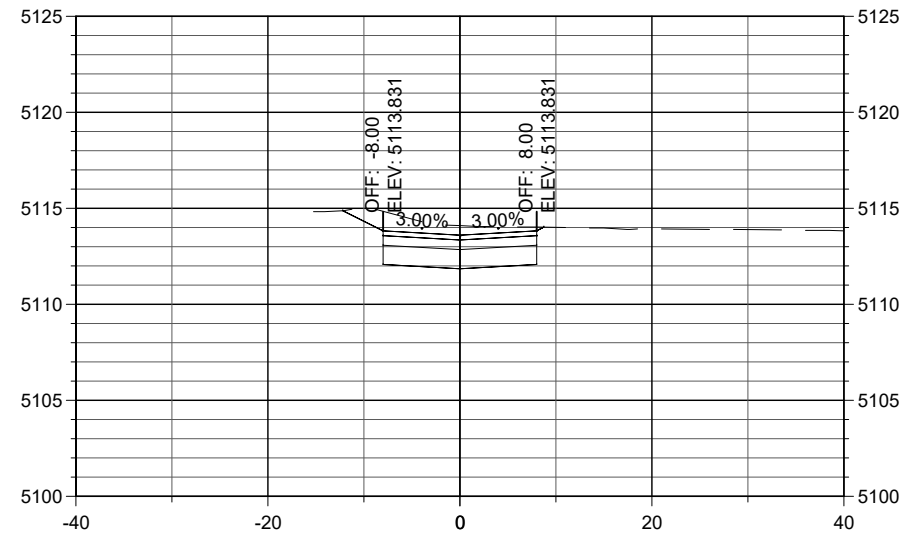

STA. 54+00

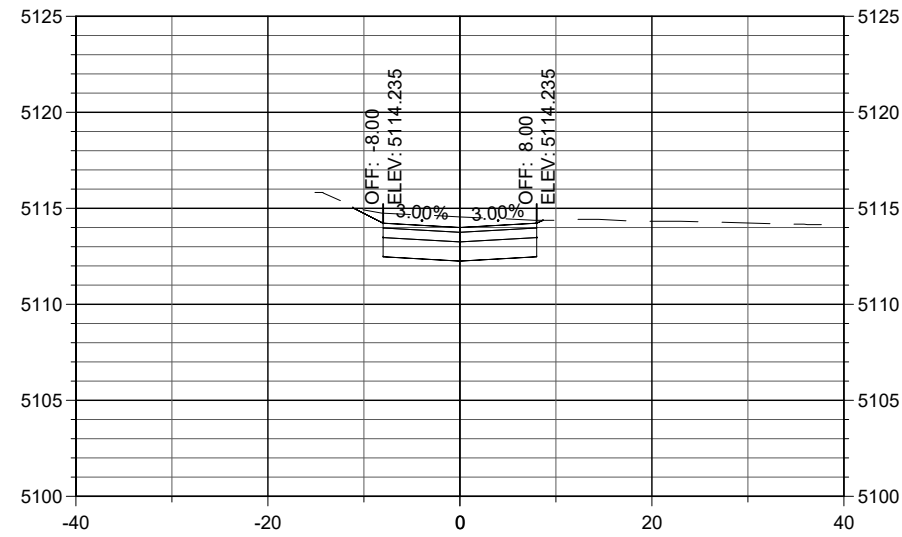

STA. 54+20

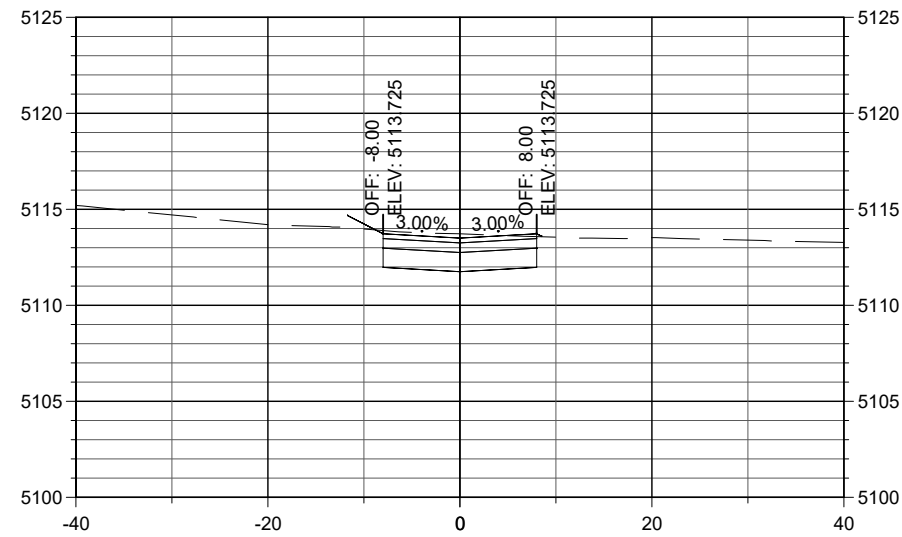

STA. 53+60

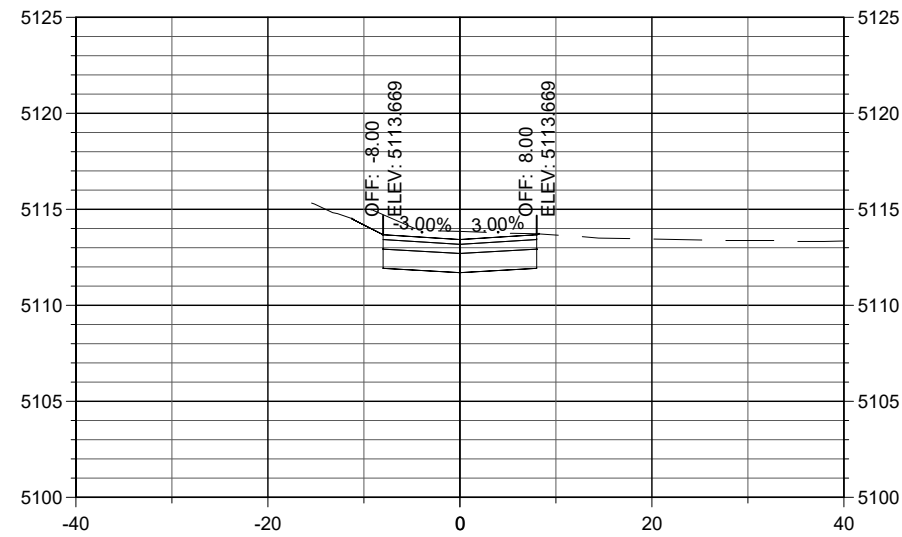

STA. 53+80

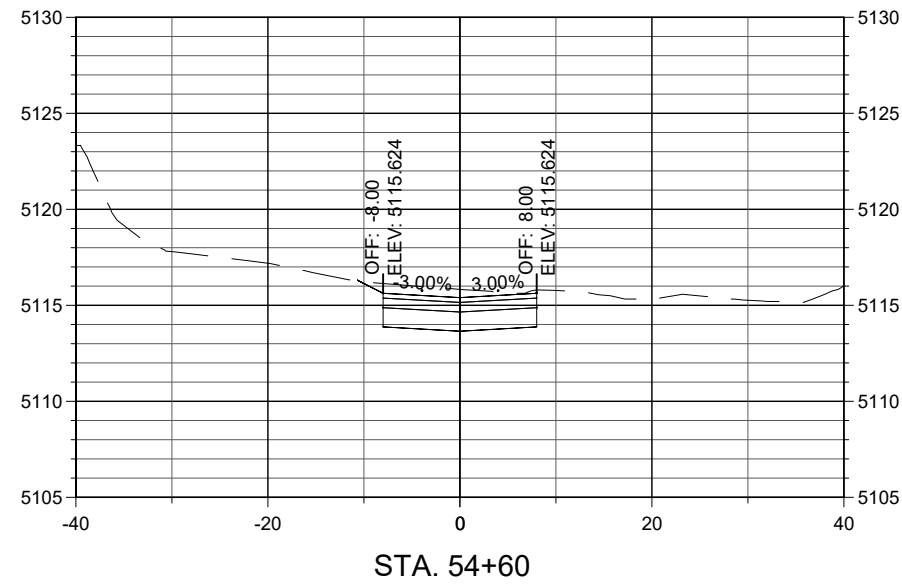
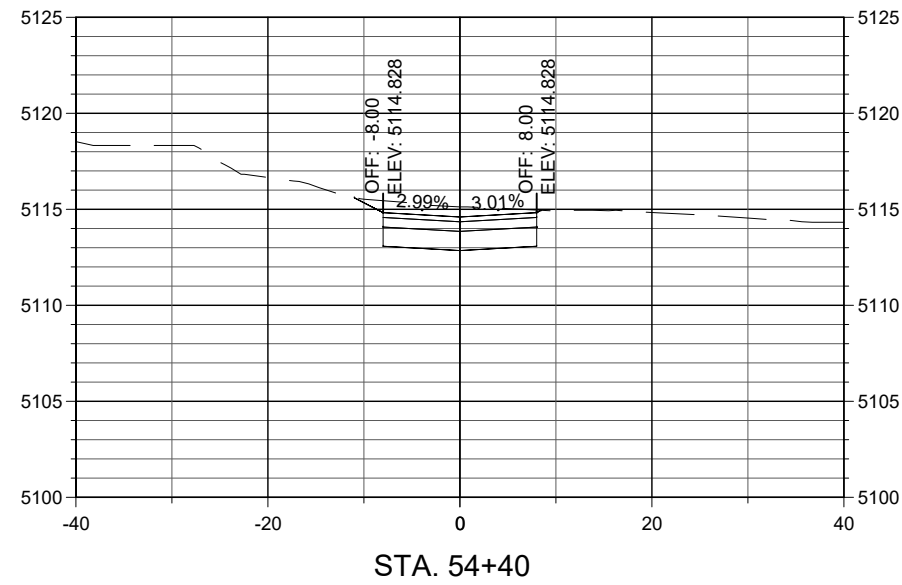
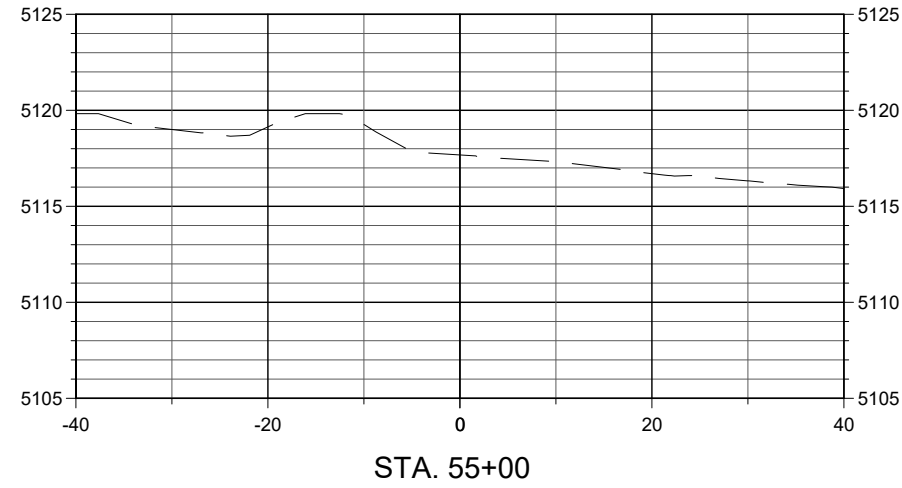
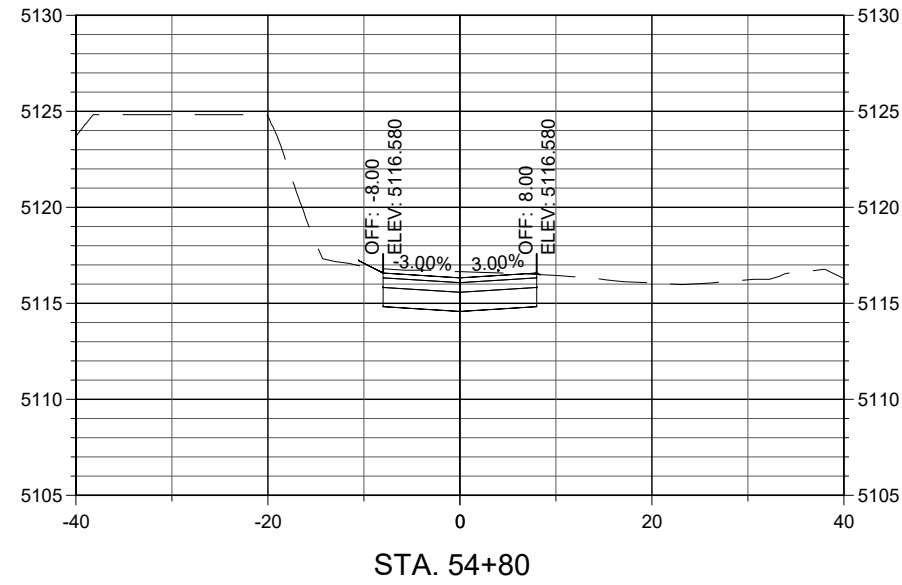

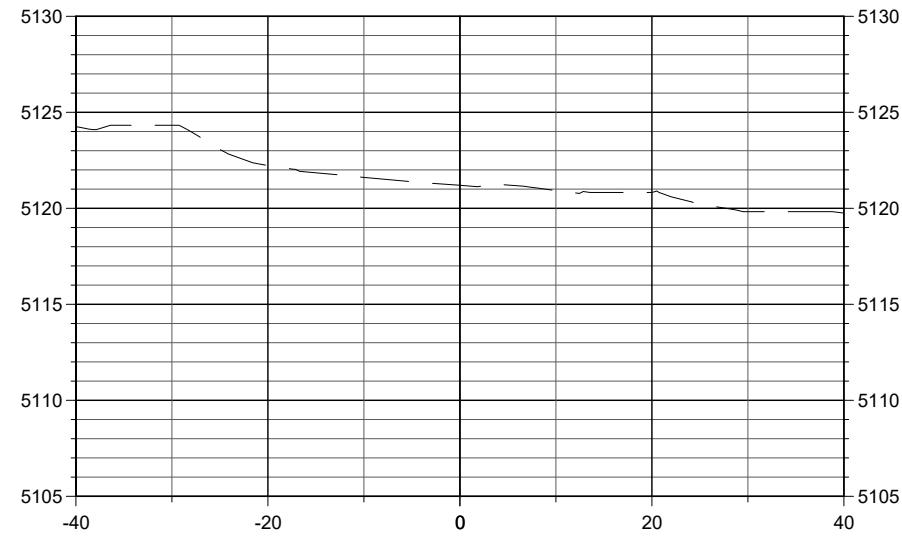

STA. 55+60

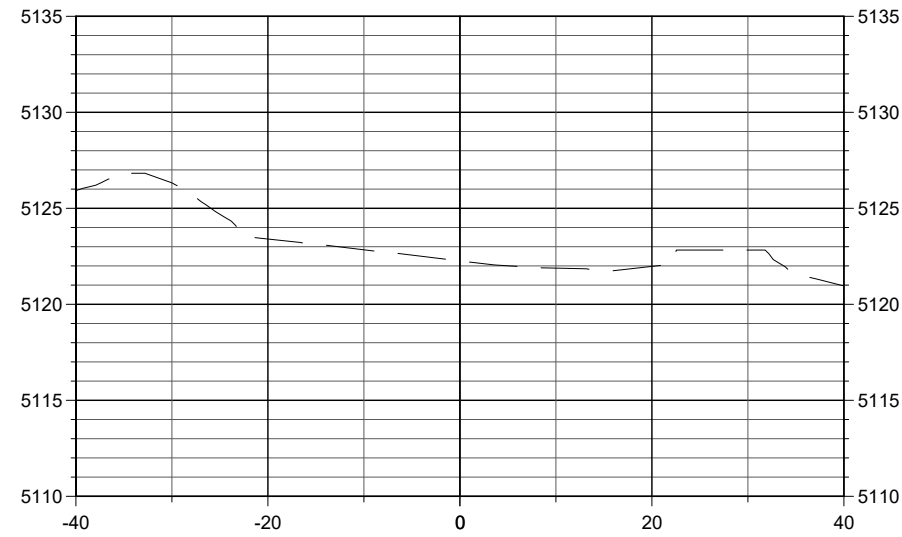

STA. 55+80

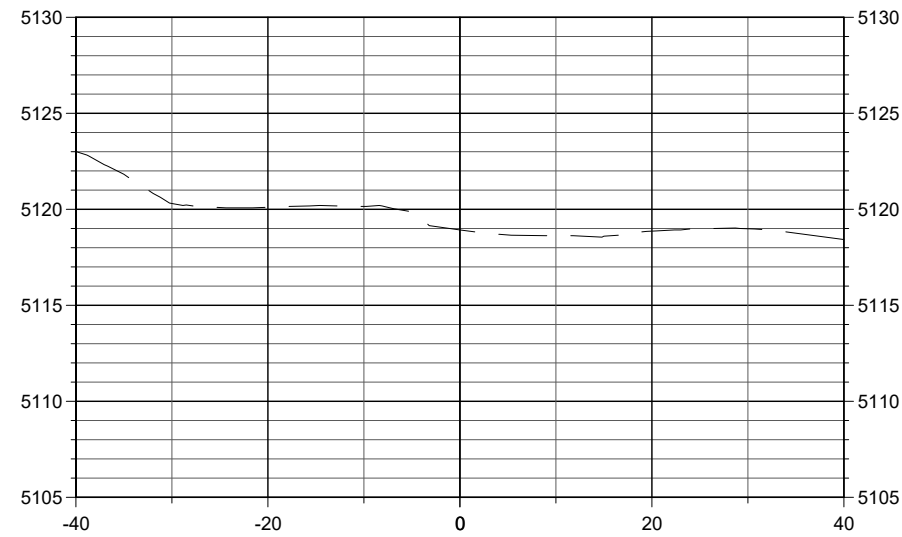

STA. 55+20

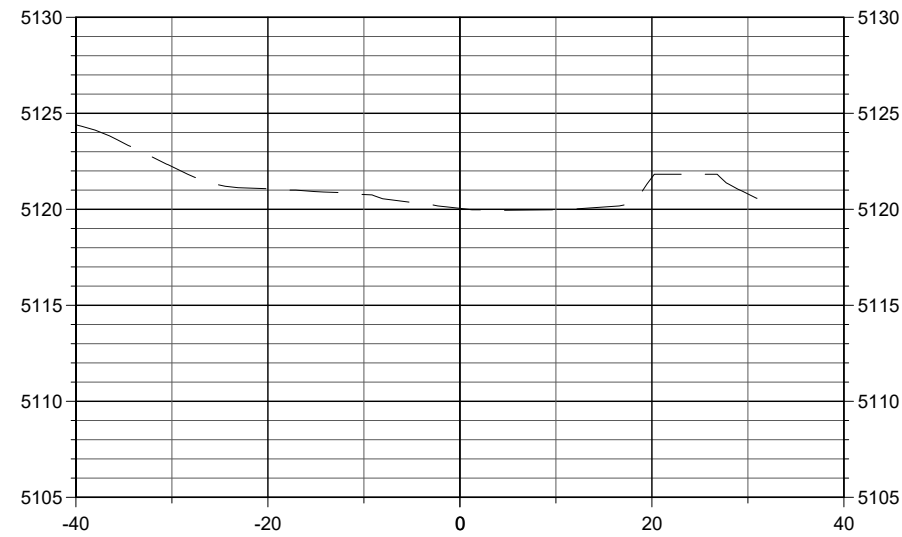

STA. 55+40



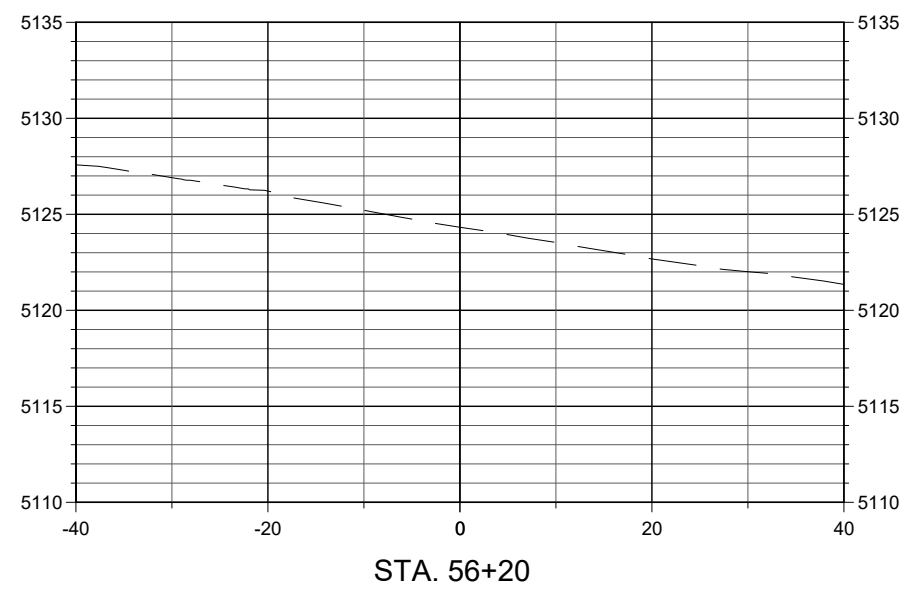
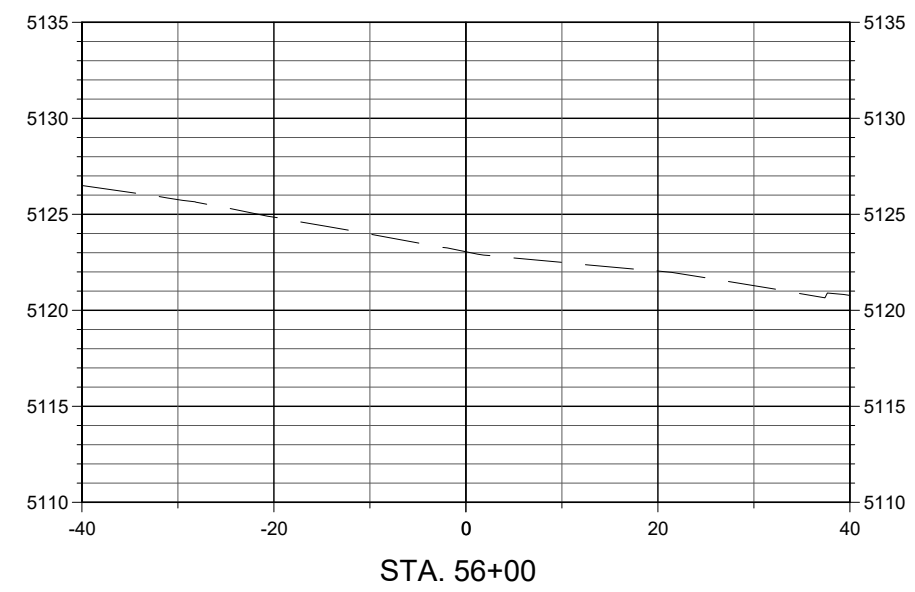

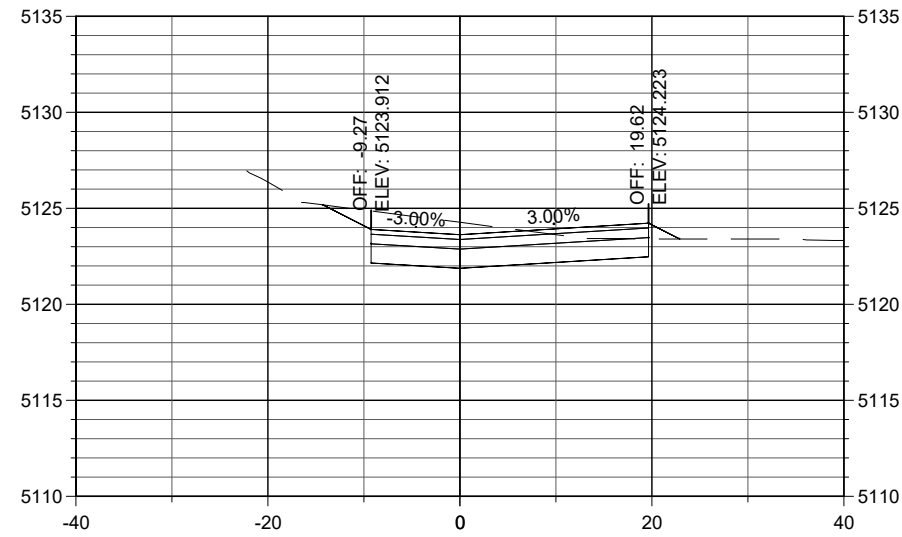

STA. 70+60

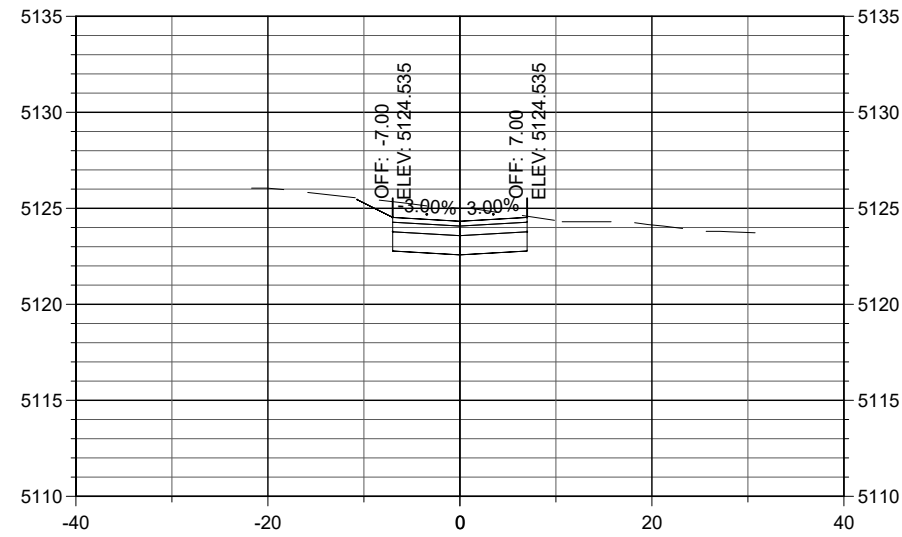

STA. 70+80

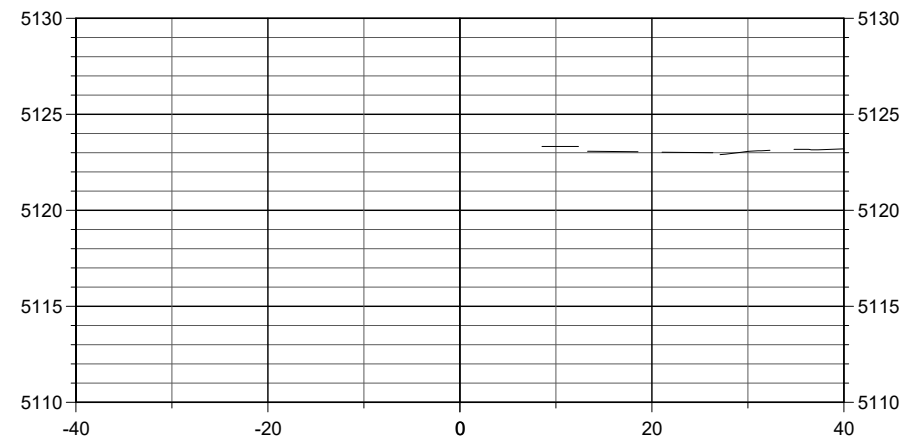

STA. 70+20

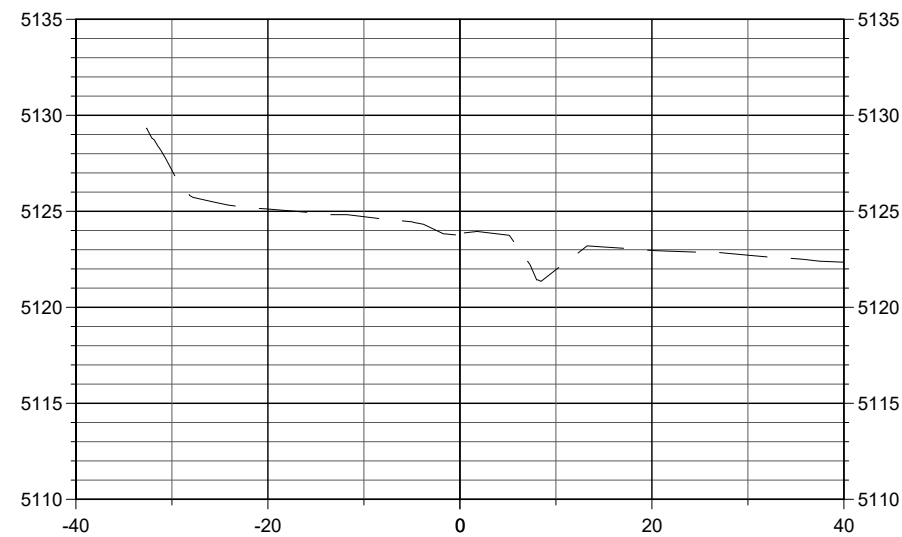

STA. 70+40

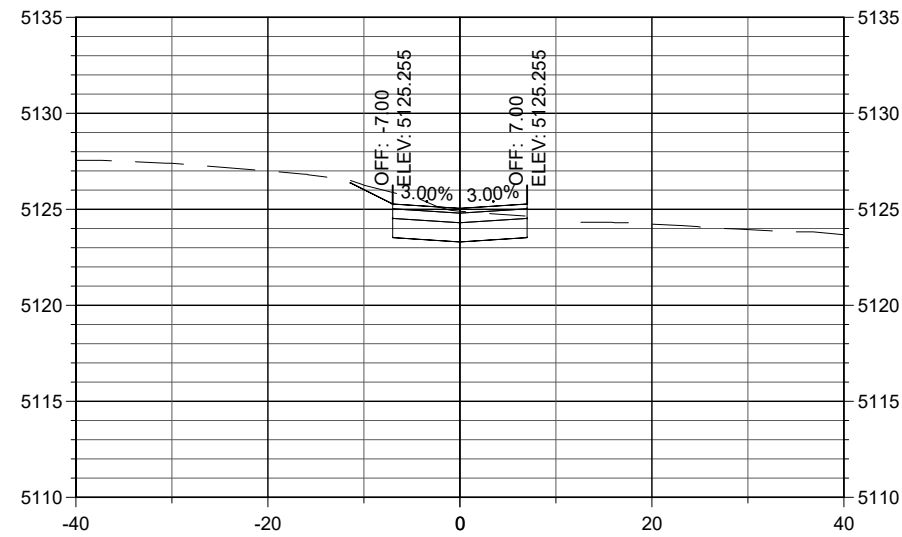
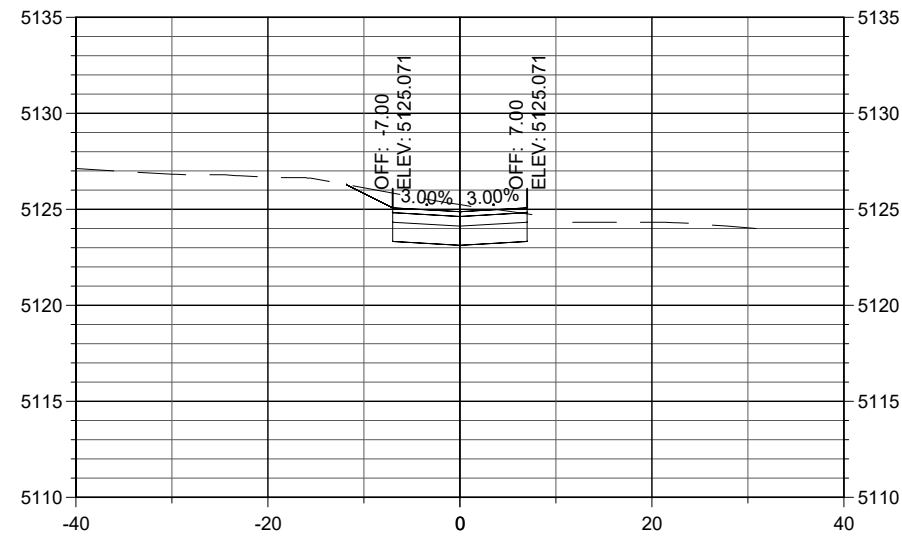
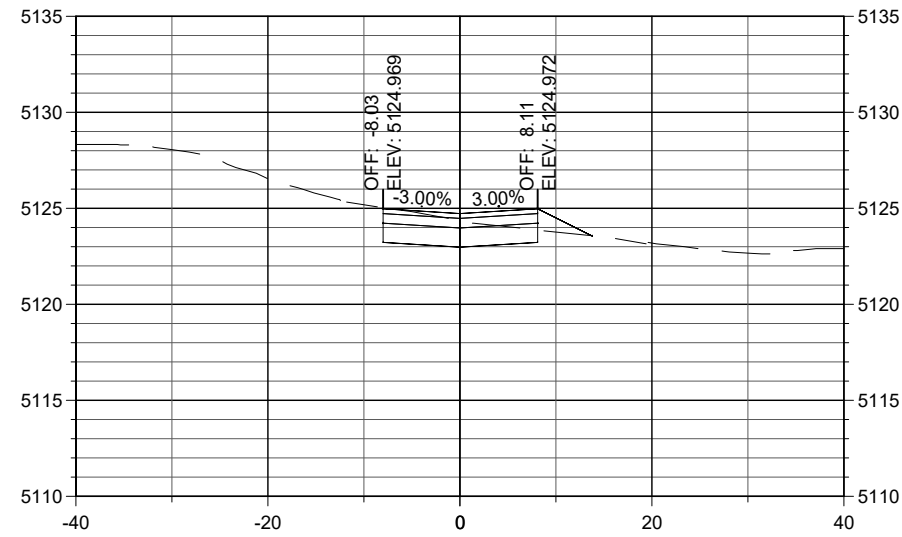
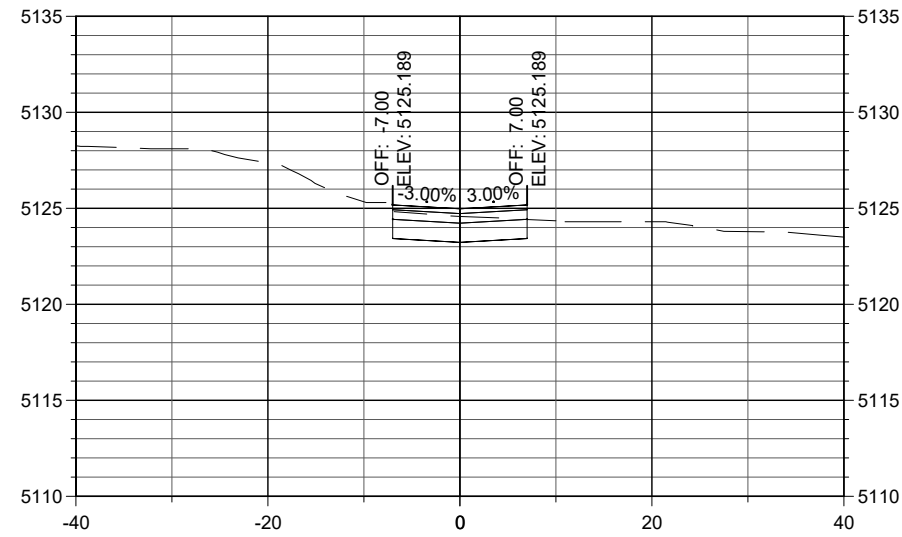

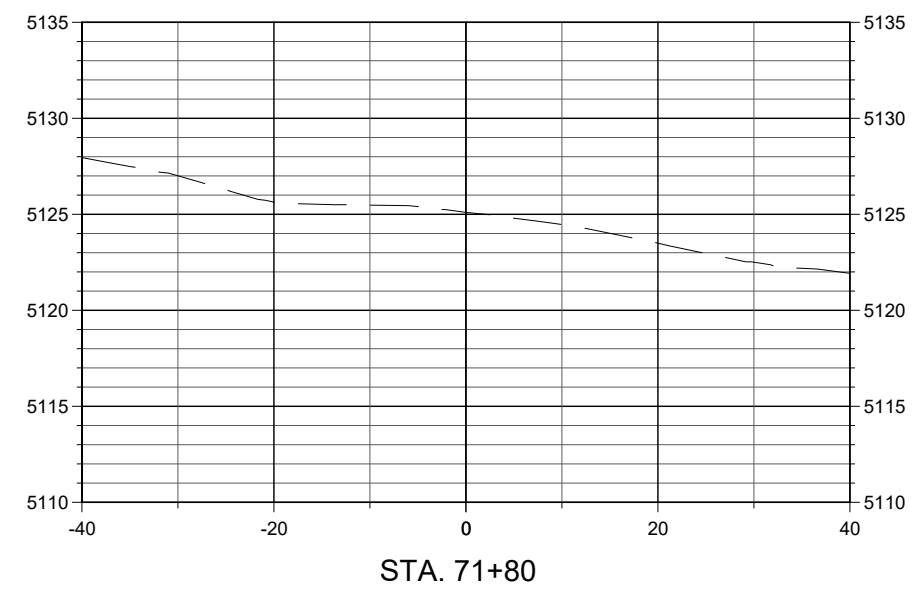

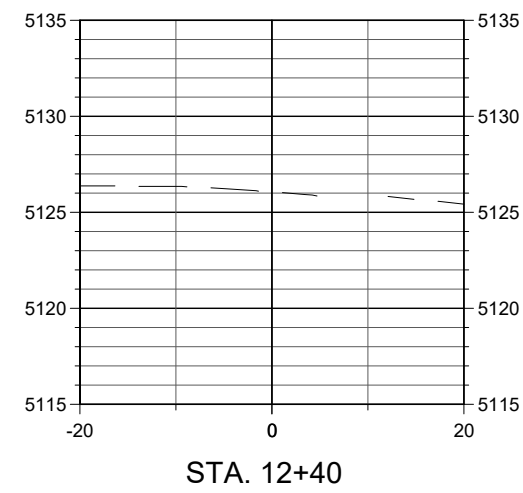
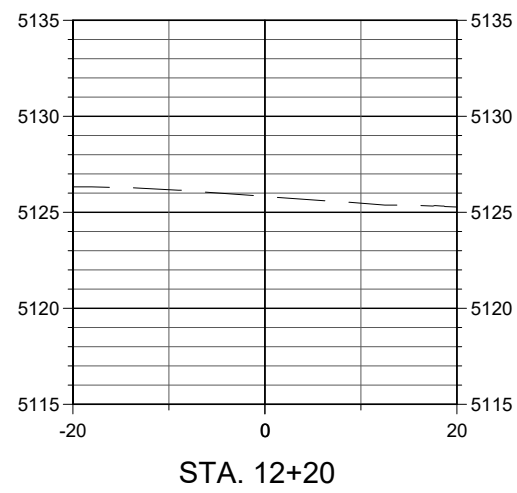

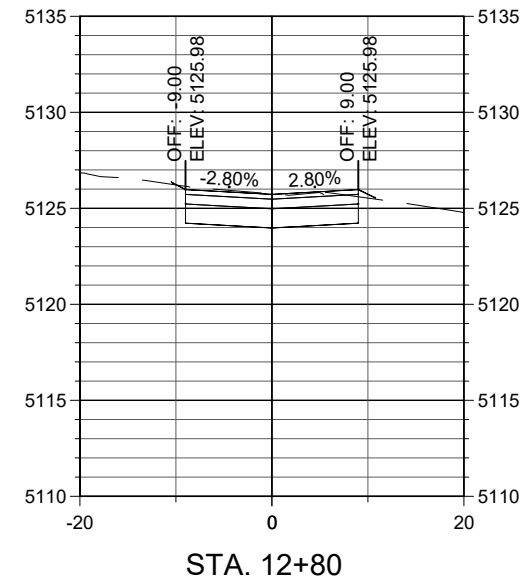
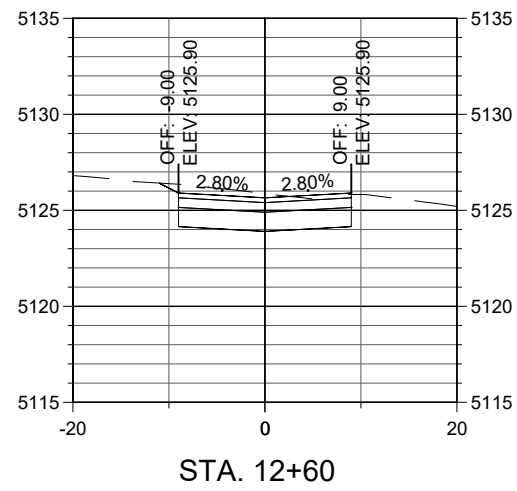

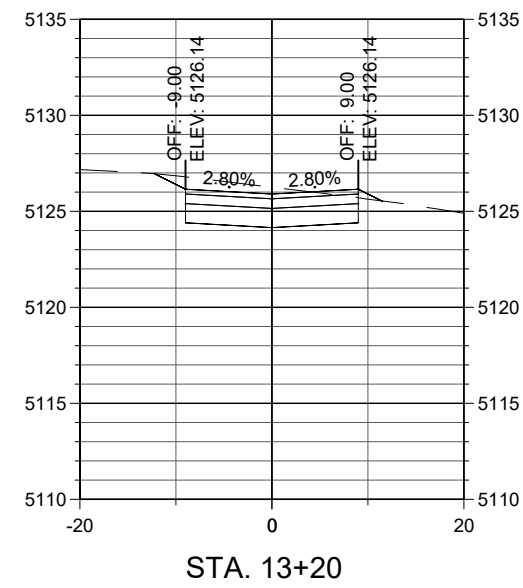
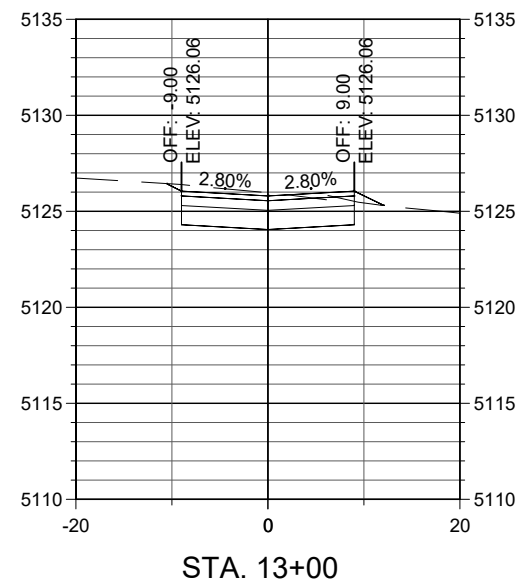

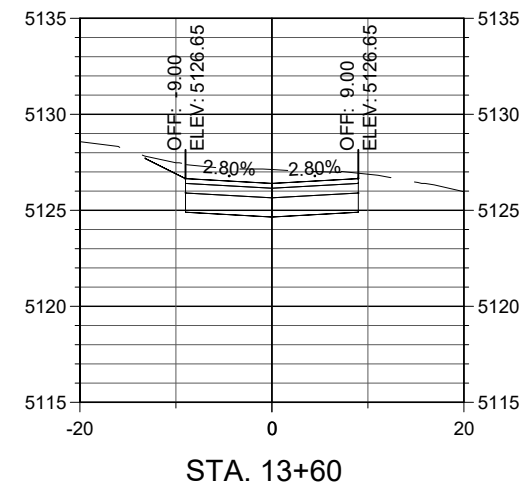
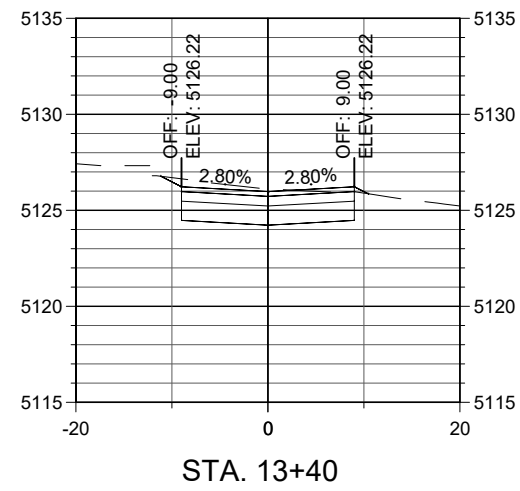



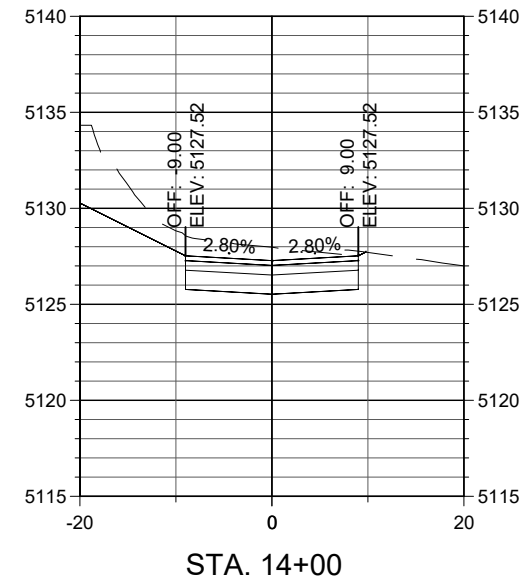
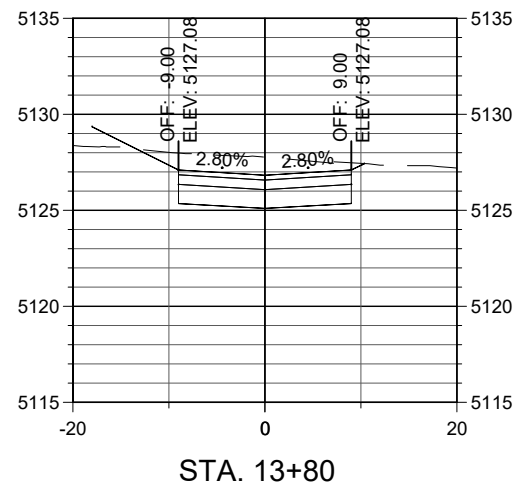

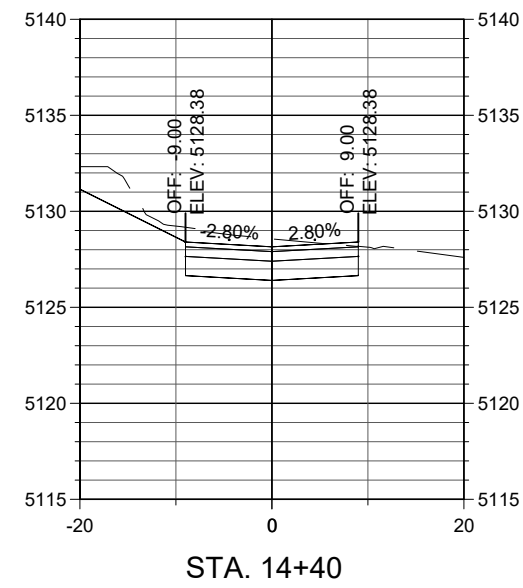
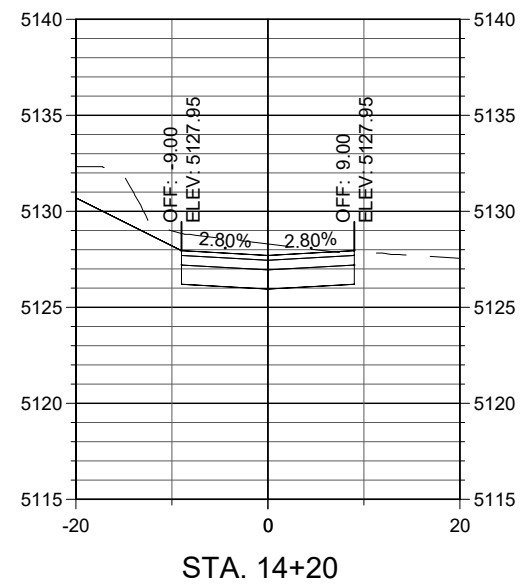

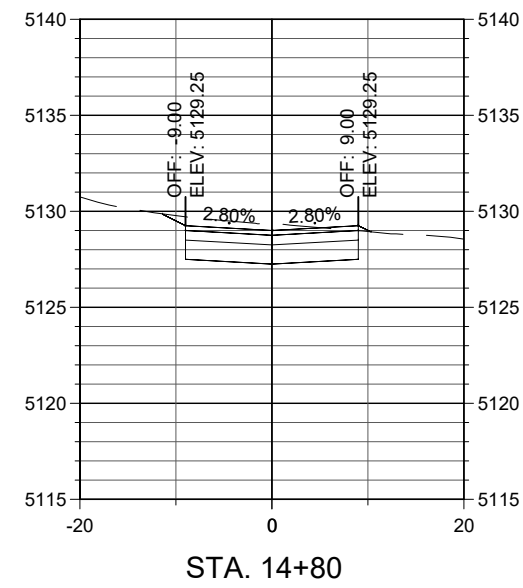
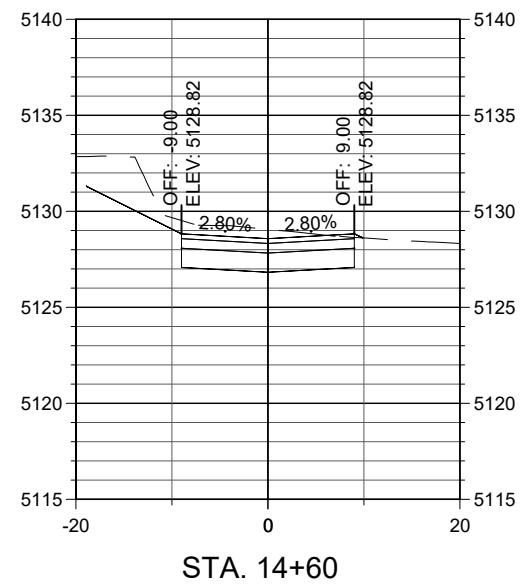

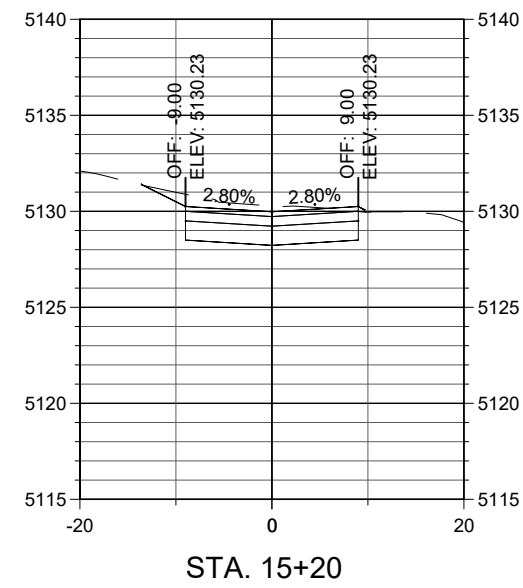
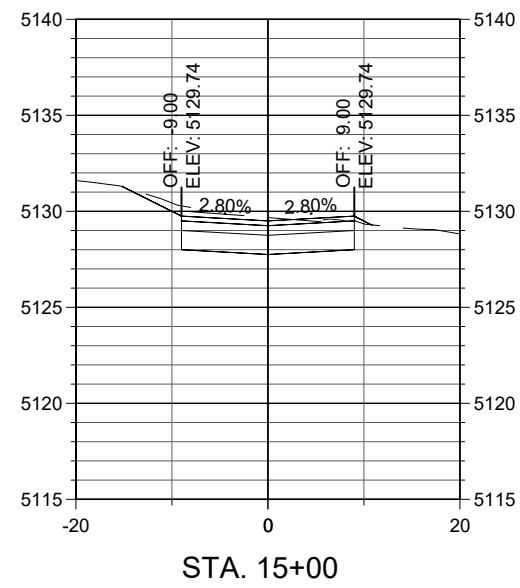

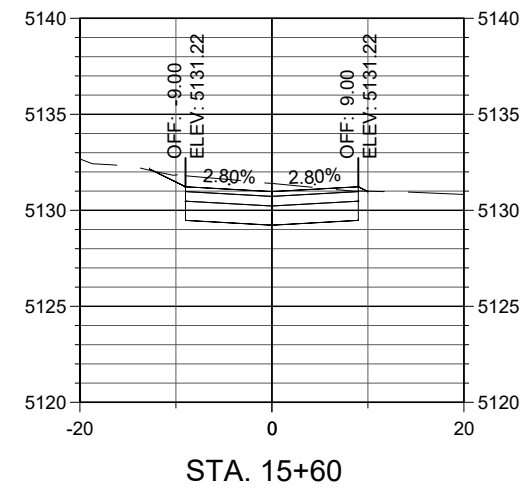
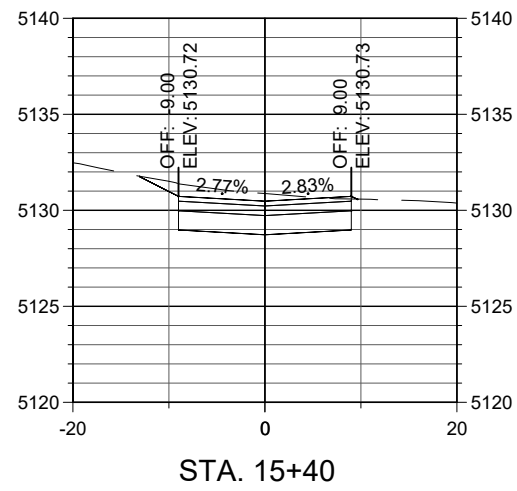

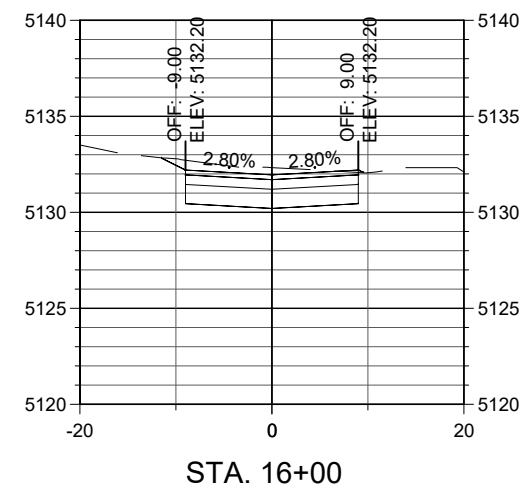
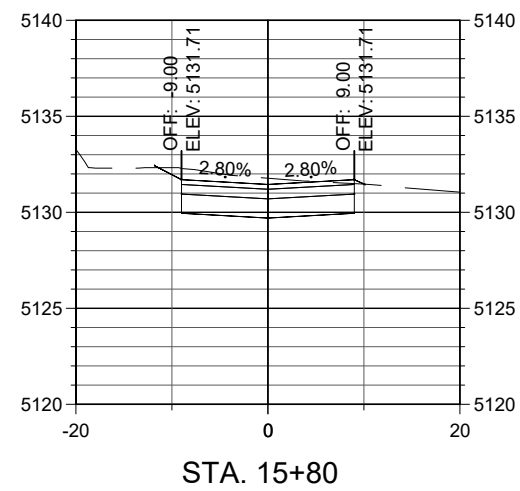

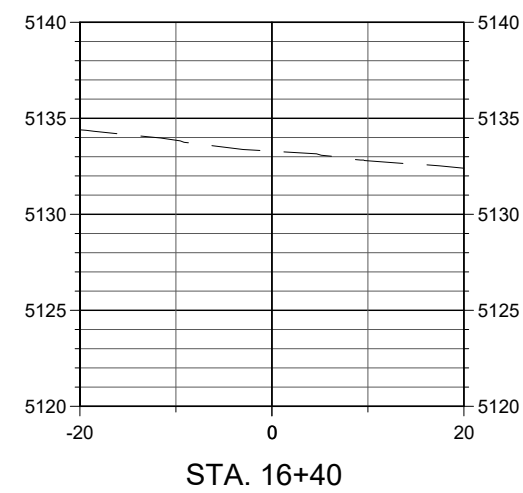
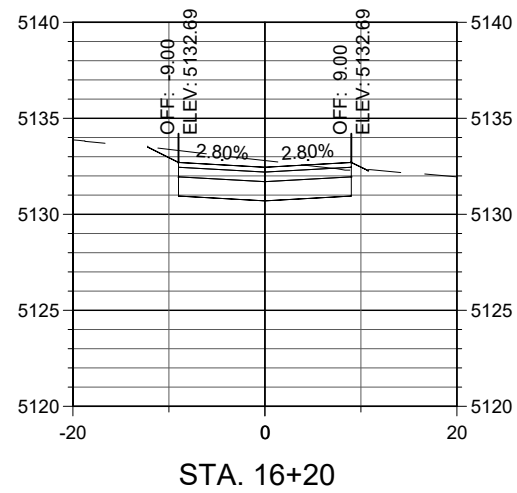

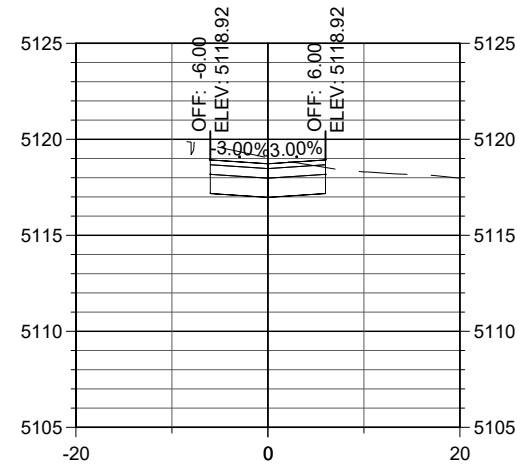

STA. 23+80

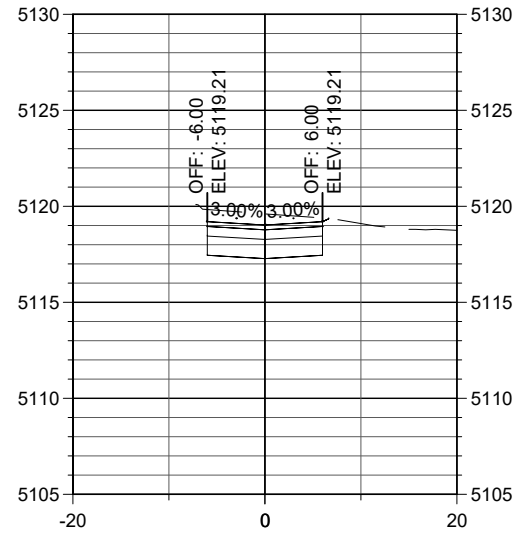

STA. 24+00

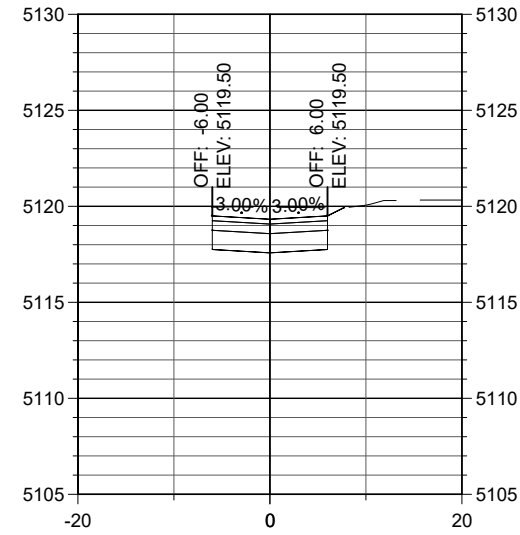

STA. 24+20

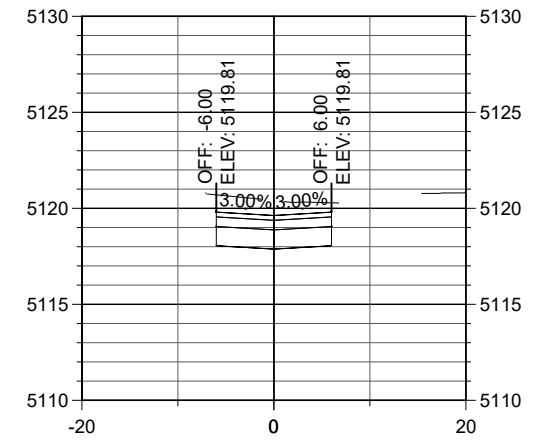

STA. 24+40

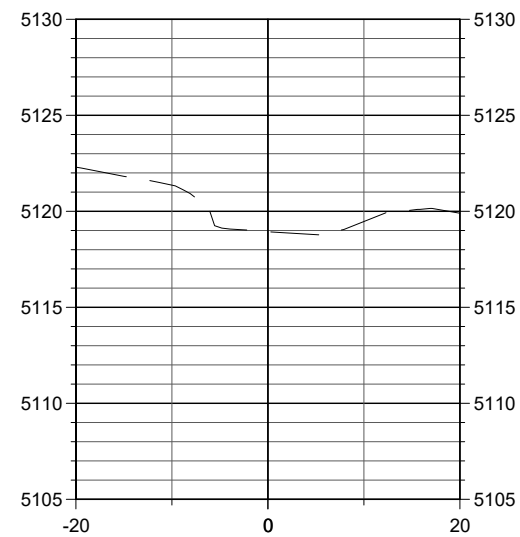

STA. 23+00

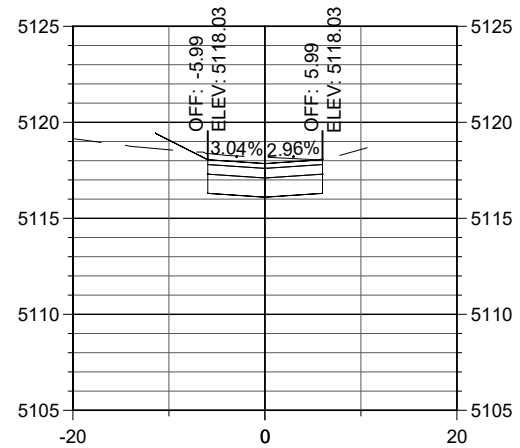

STA. 23+20

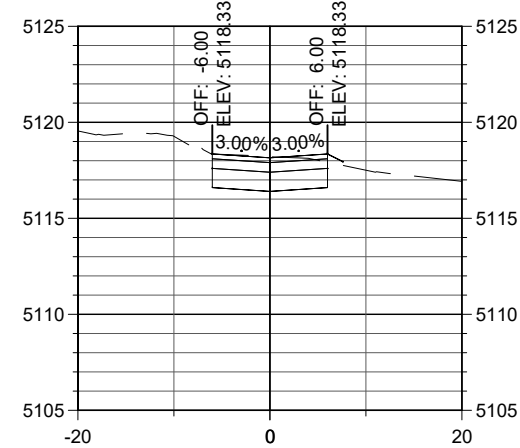

STA. 23+40

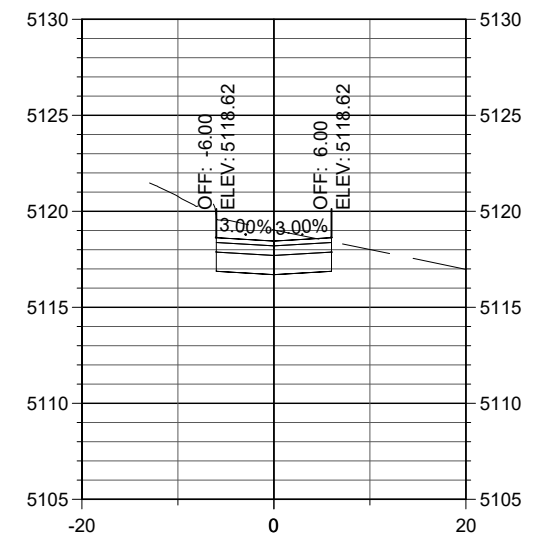

STA. 23+60



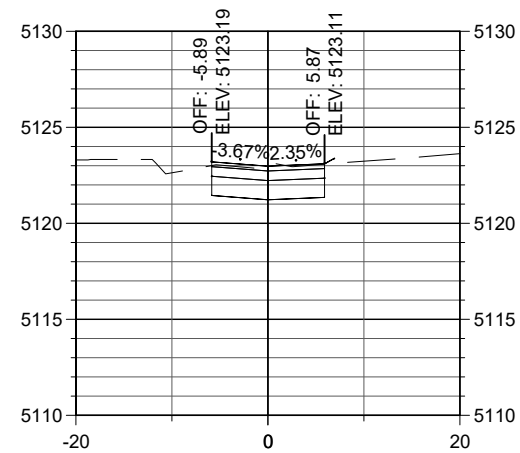

STA. 25+40

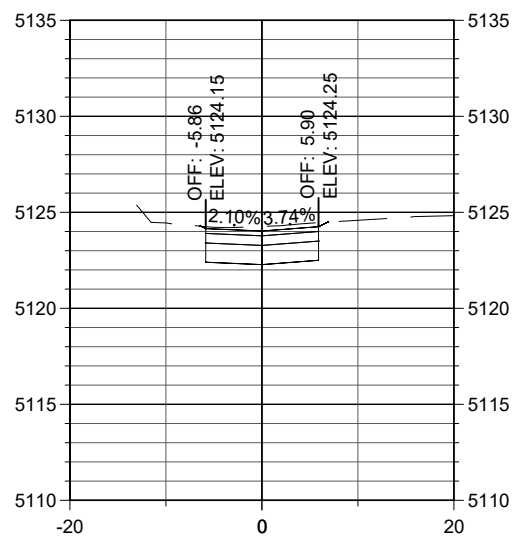

STA. 25+60

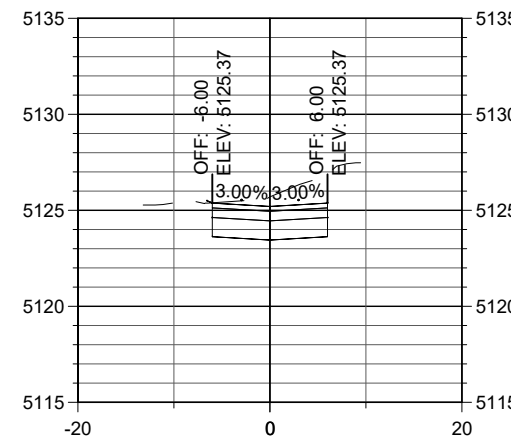

STA. 25+80

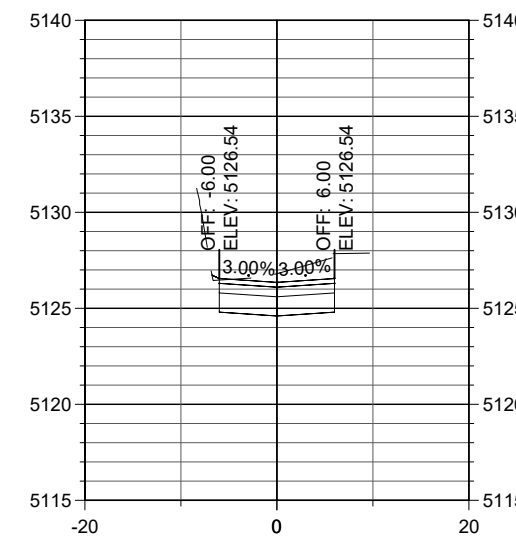

STA. 26+00

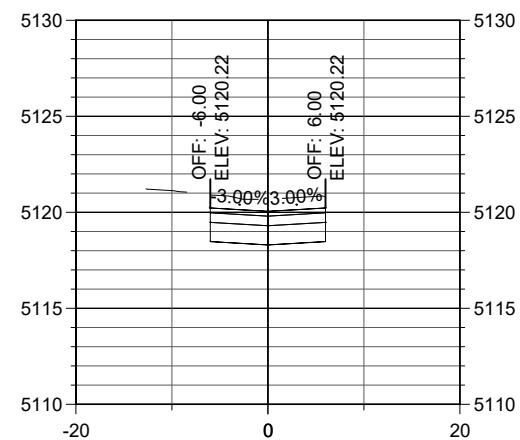

STA. 24+60

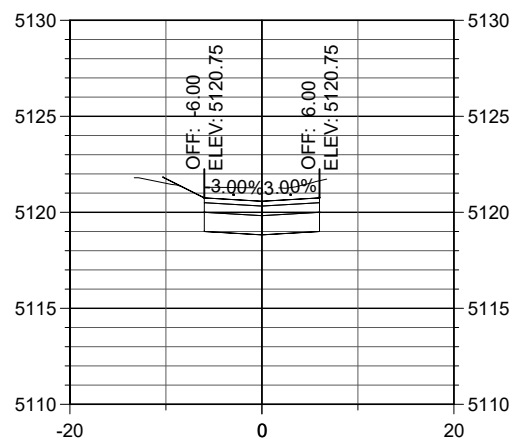

STA. 24+80

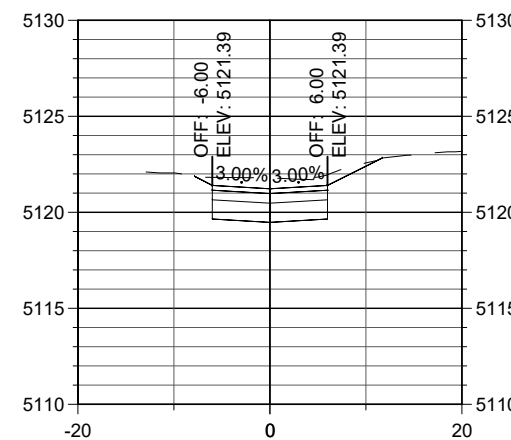

STA. 25+00

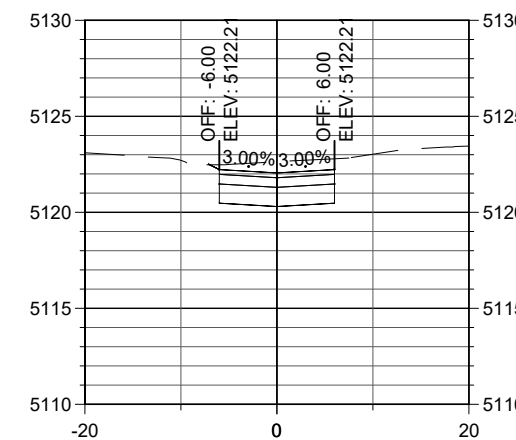

STA. 25+20

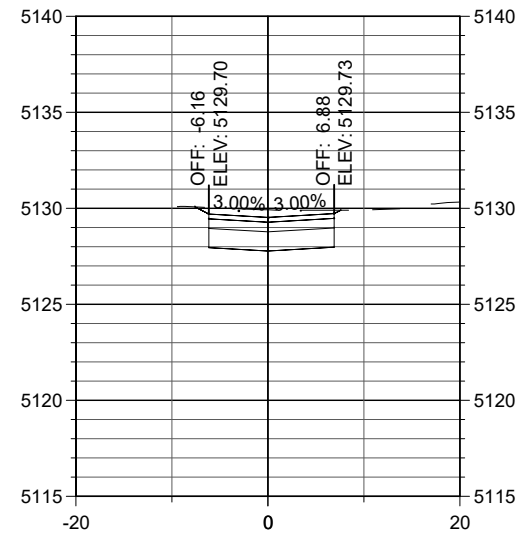

STA. 27+00

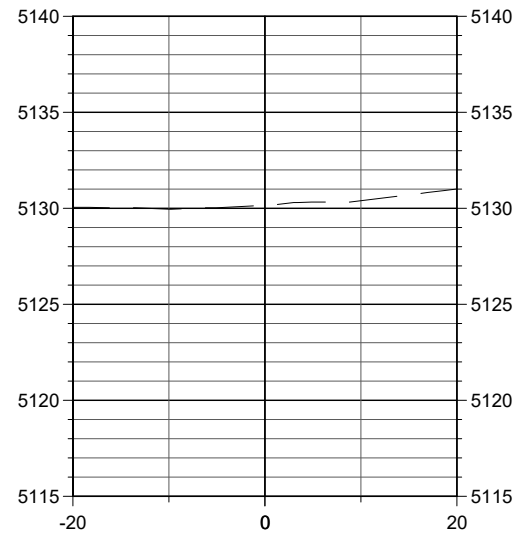

STA. 27+20

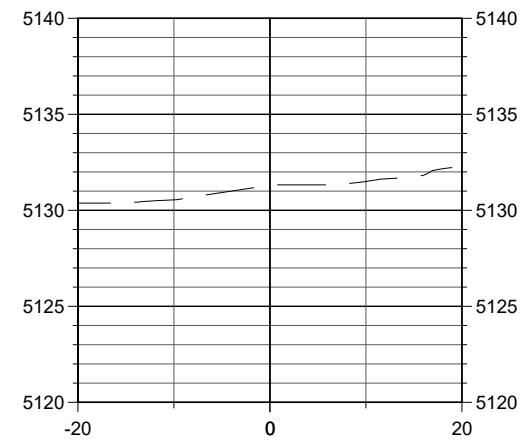

STA. 27+40

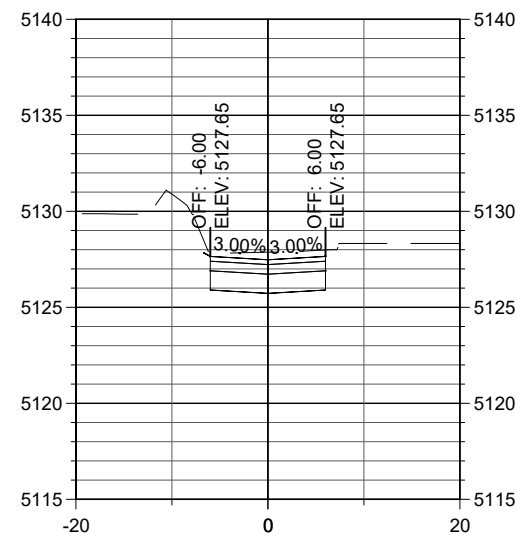

STA. 26+20

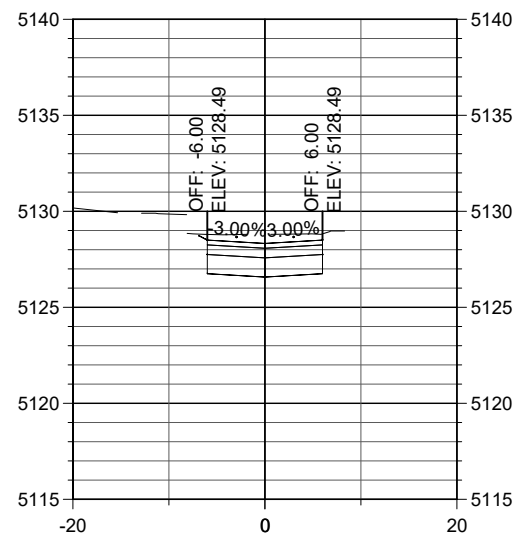

STA. 26+40

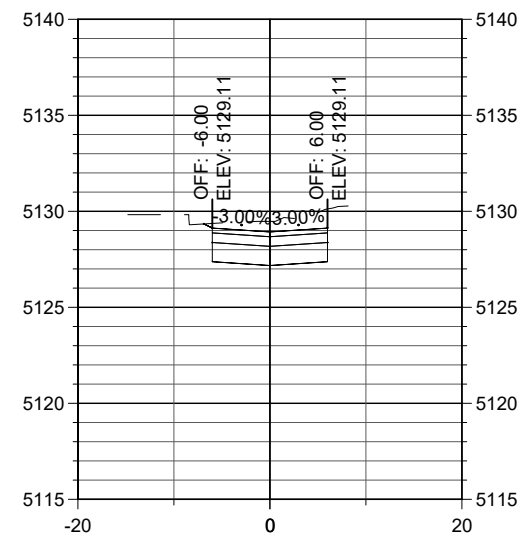

STA. 26+60

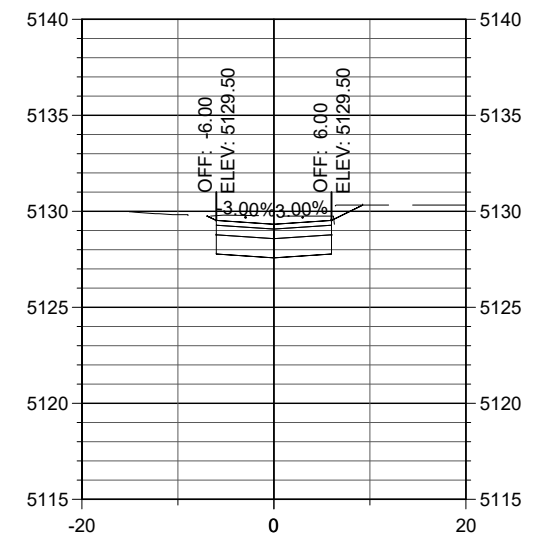

STA. 26+80

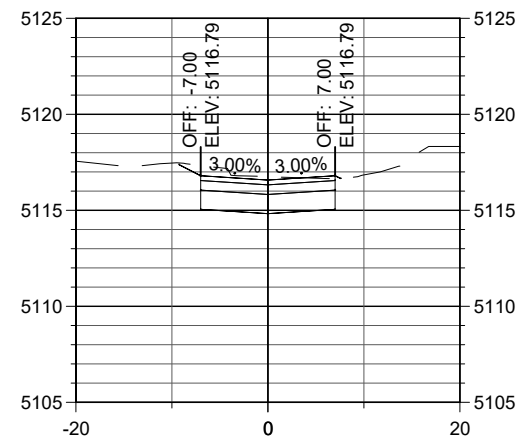

STA. 31+20

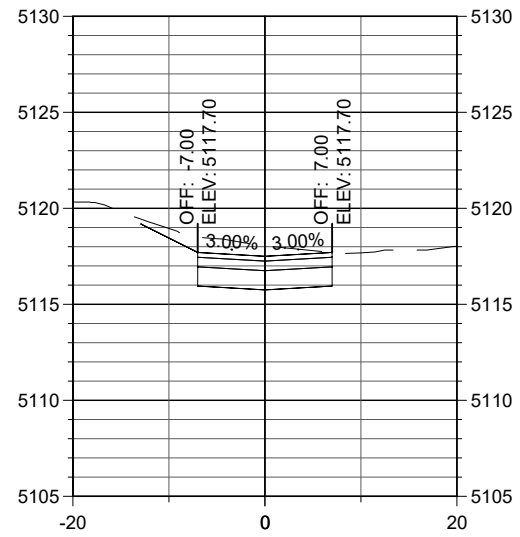

STA. 31+40

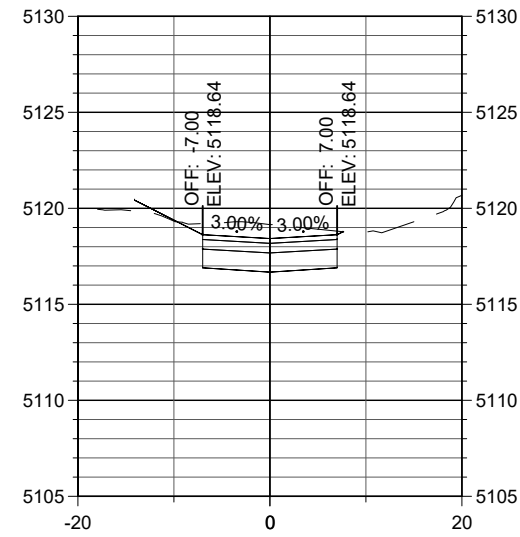

STA. 31+60

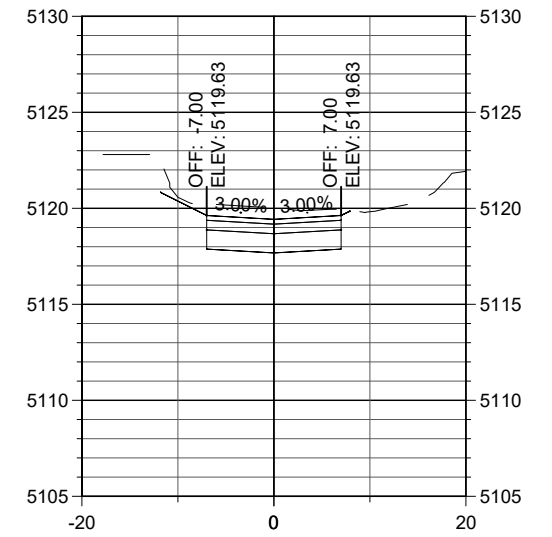

STA. 31+80

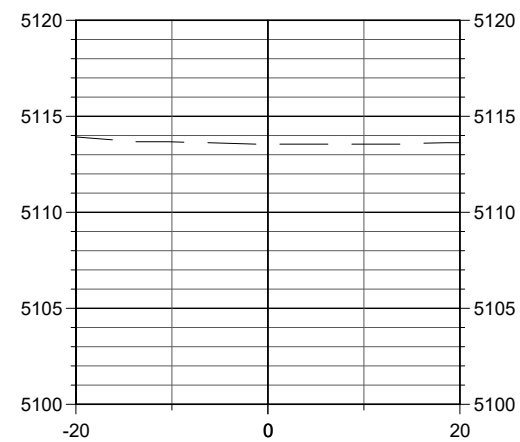

STA. 30+40

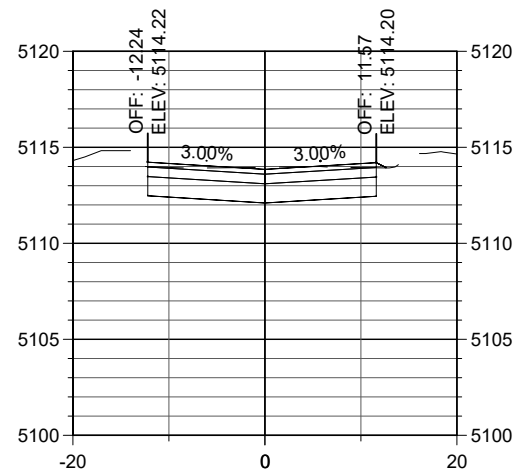

STA. 30+60

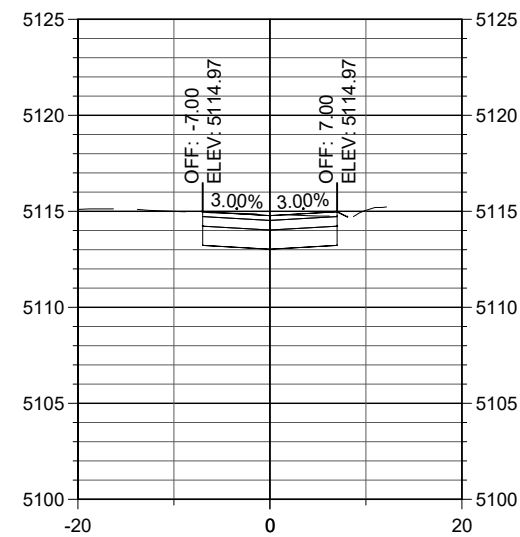

STA. 30+80

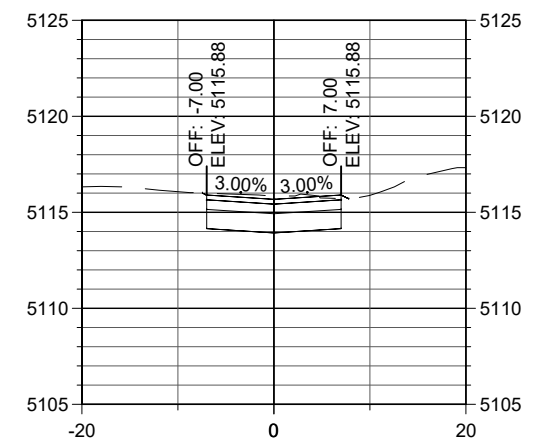

STA. 31+00

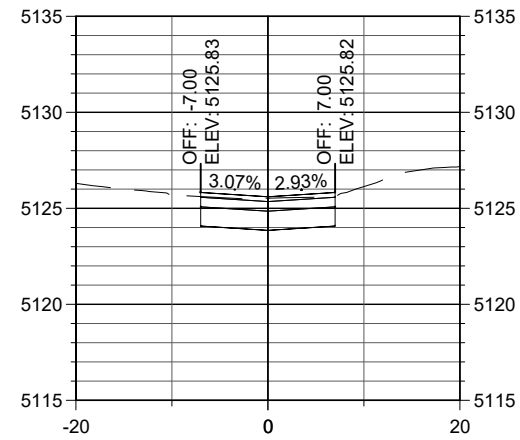

STA. 32+80

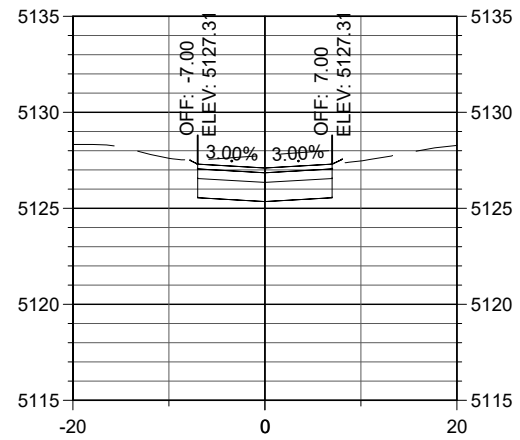

STA. 33+00

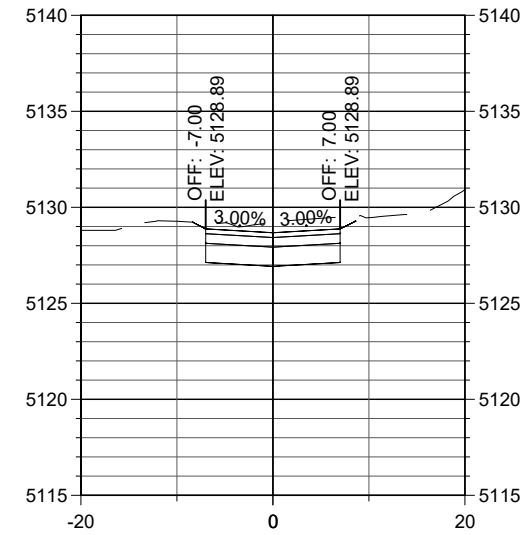

STA. 33+20

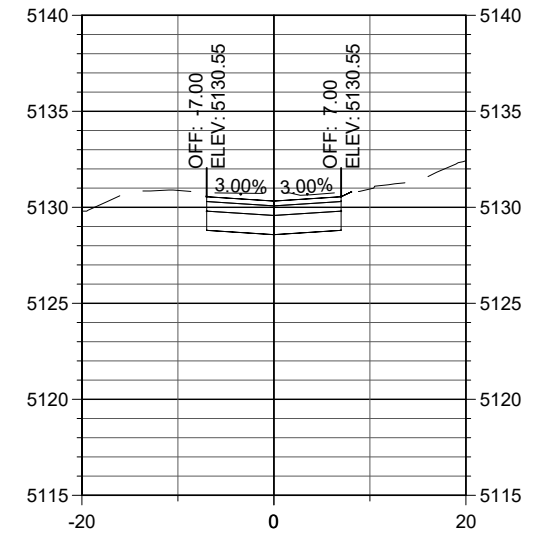

STA. 33+40

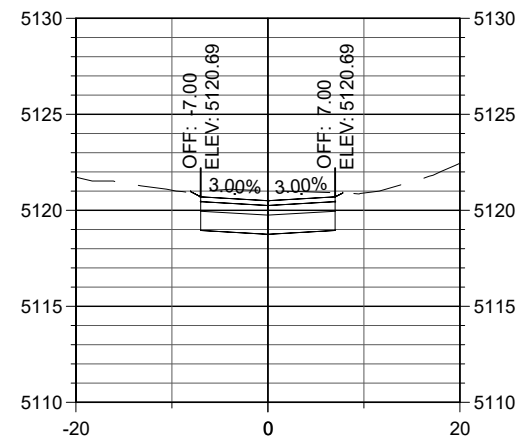

STA. 32+00

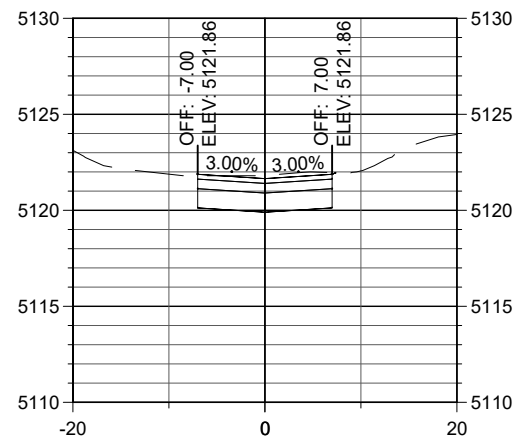

STA. 32+20

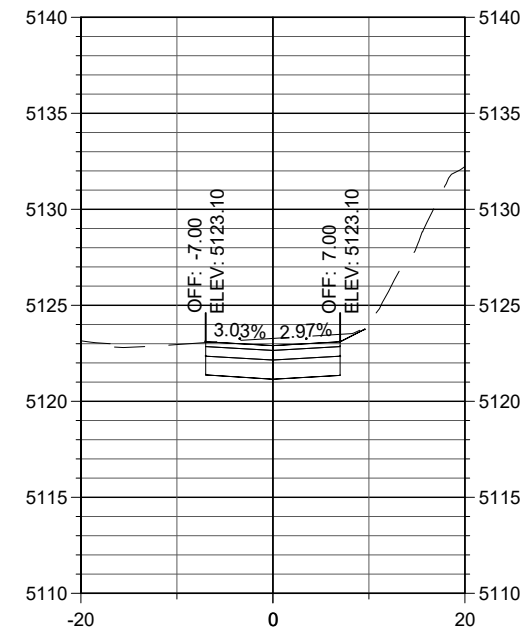

STA. 32+40

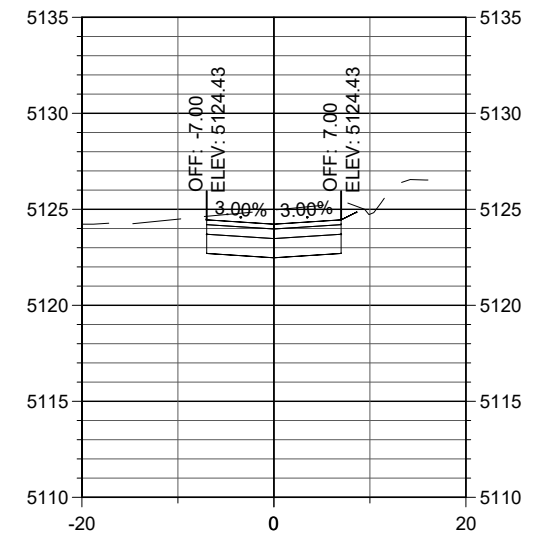

STA. 32+60

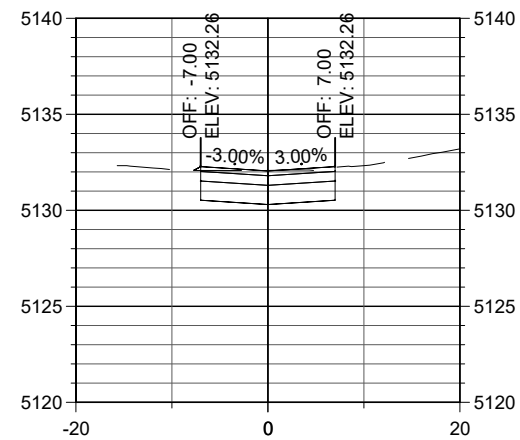

STA. 33+60

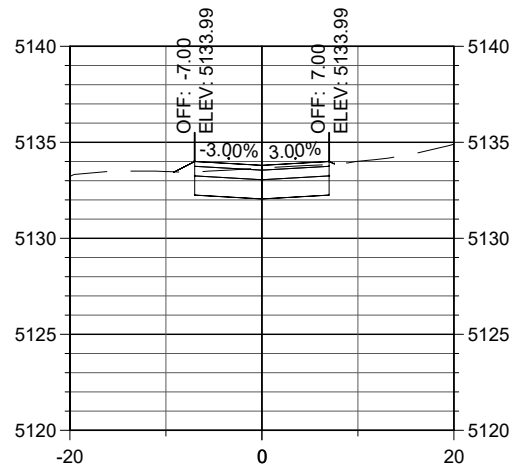

STA. 33+80

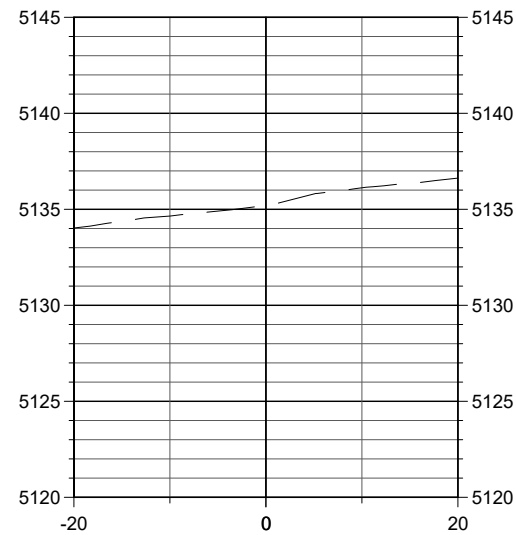

STA. 34+00

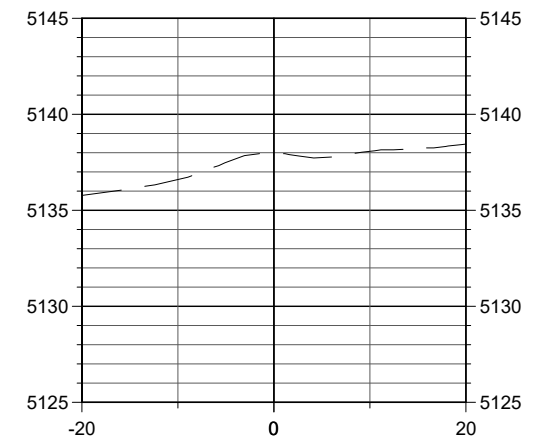

STA. 34+20

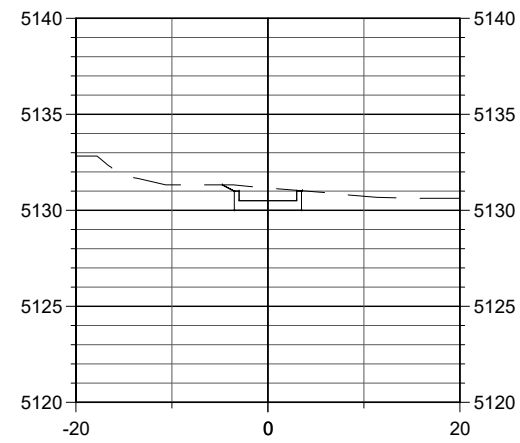

STA. 91+40

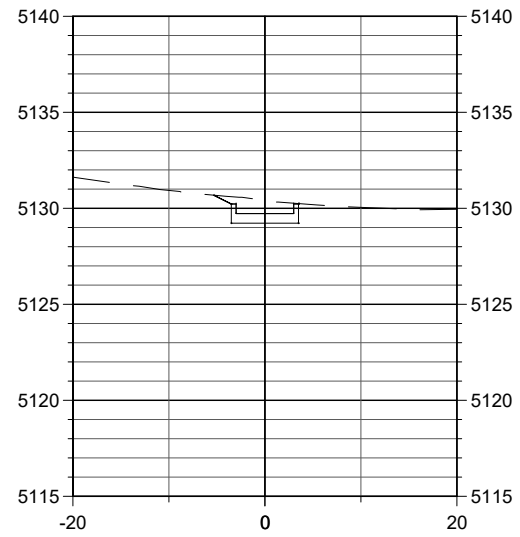

STA. 91+60

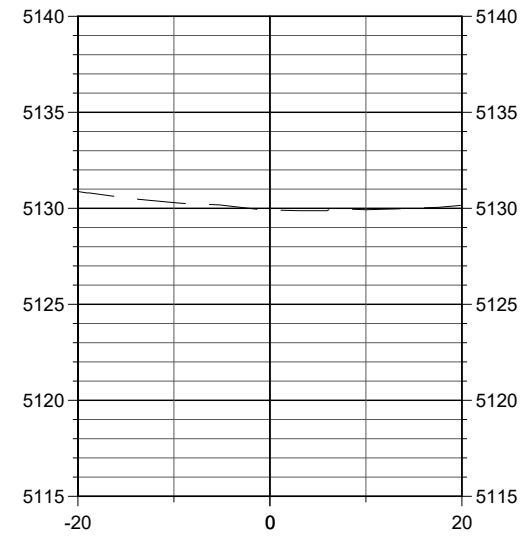

STA. 91+75

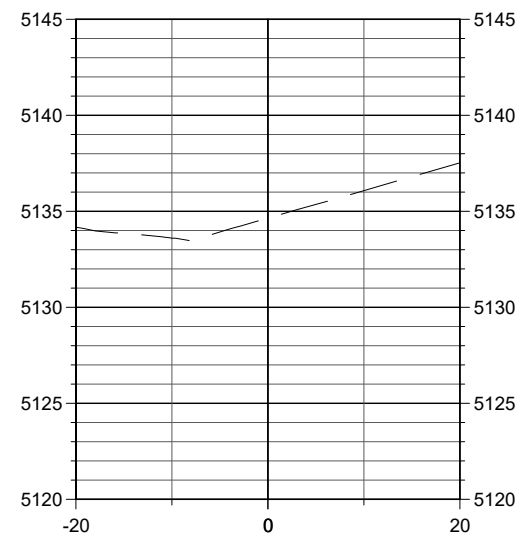

STA. 90+80

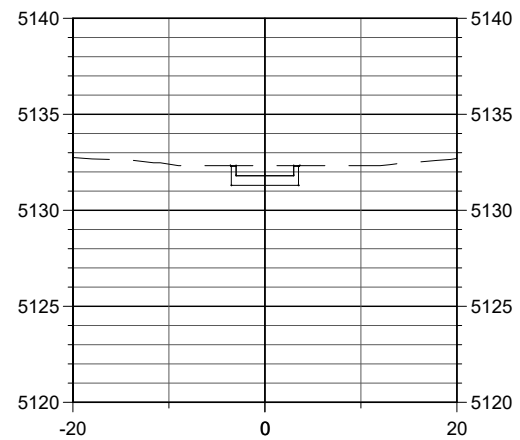

STA. 90+95

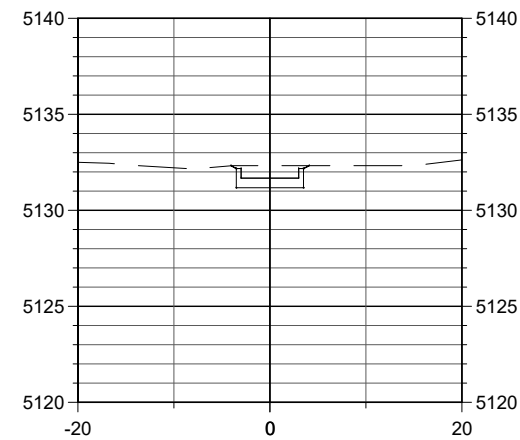

STA. 91+00

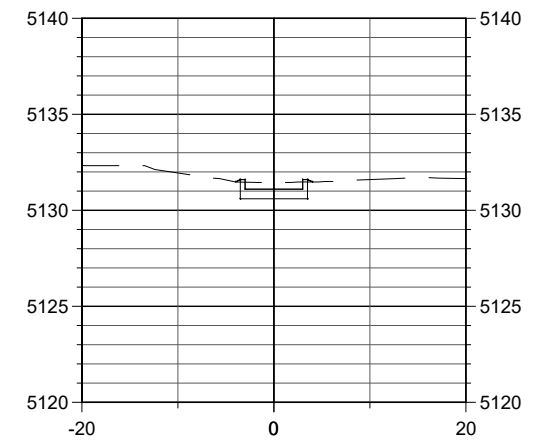

STA. 91+20

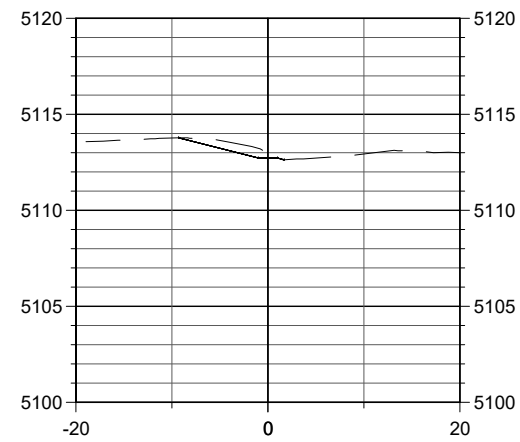

STA. 80+60

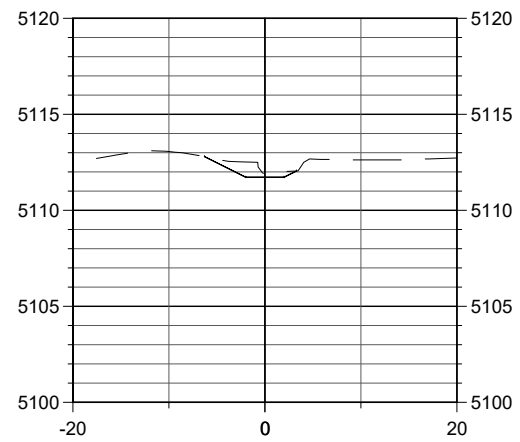

STA. 80+80

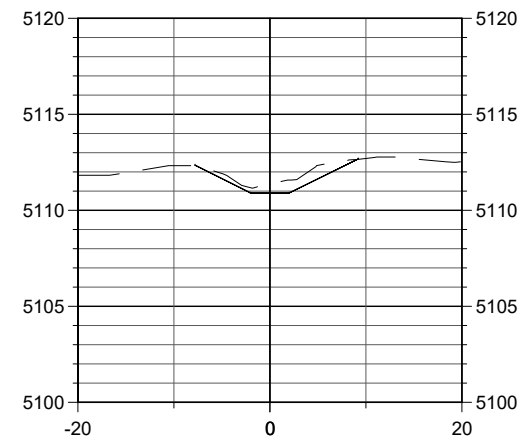

STA. 80+97

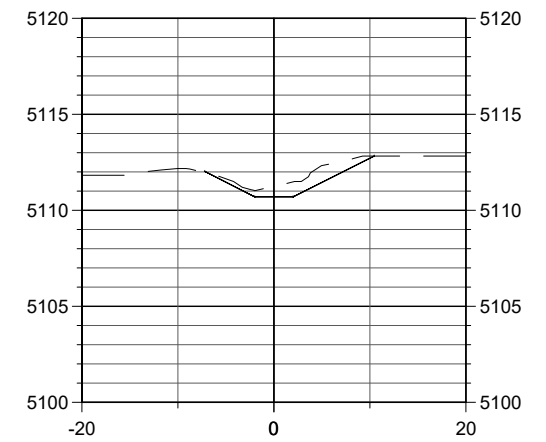

STA. 81+00

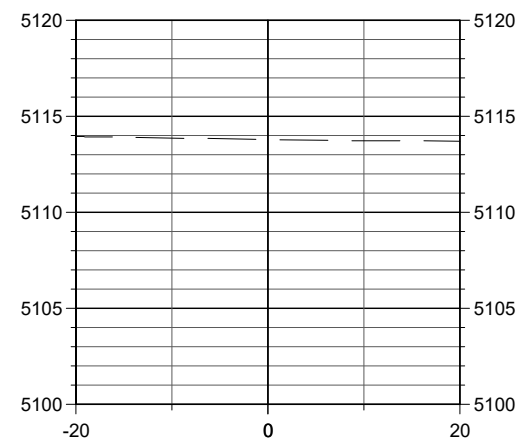

STA. 80+00

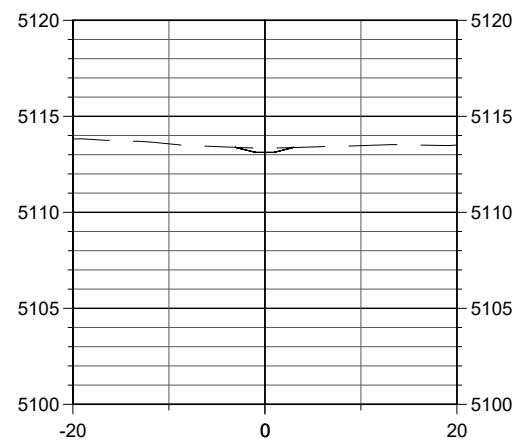

STA. 80+20

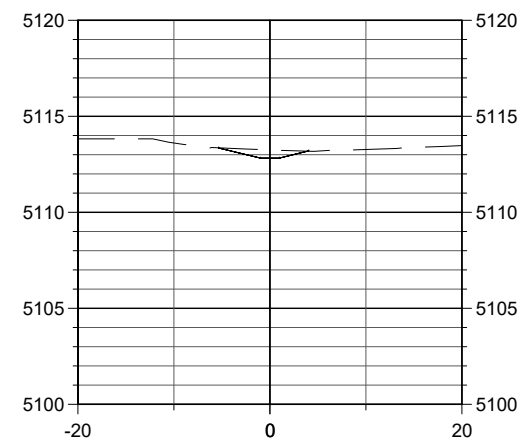

STA. 80+33

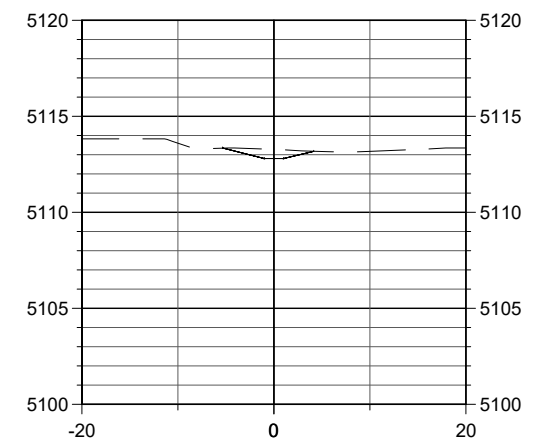

STA. 80+40

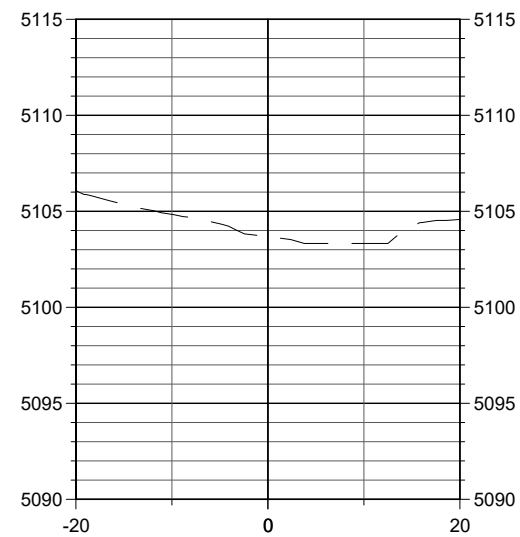

STA. 81+81

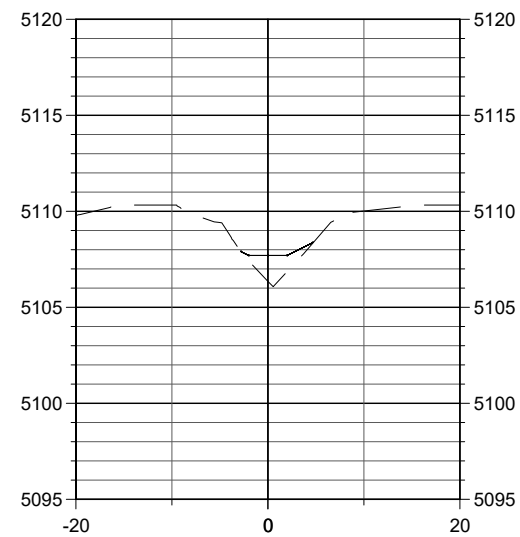

STA. 81+40

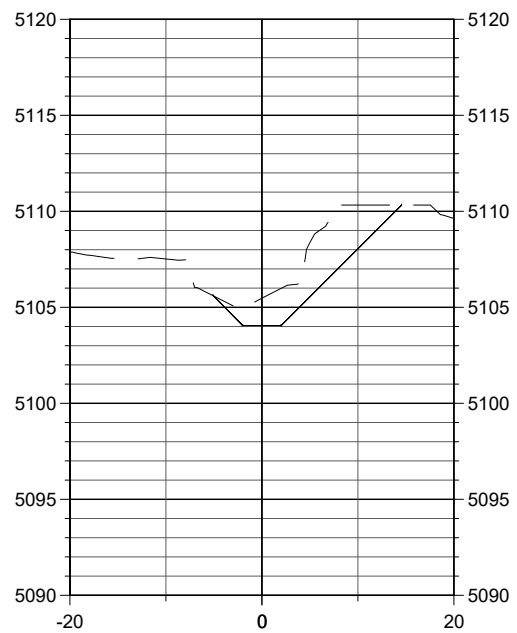

STA. 81+59

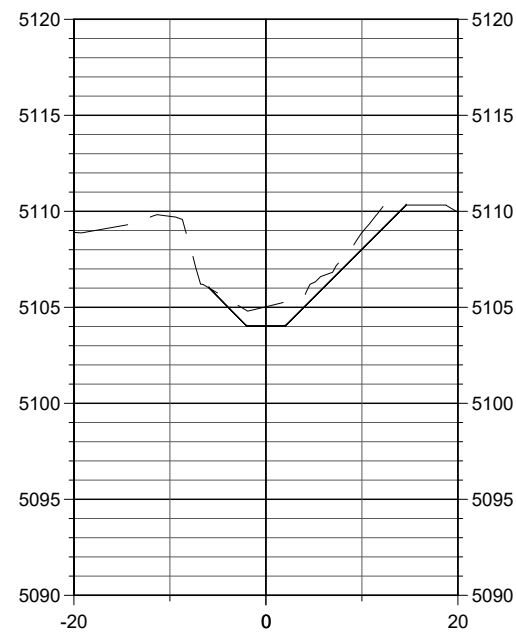

STA. 81+60

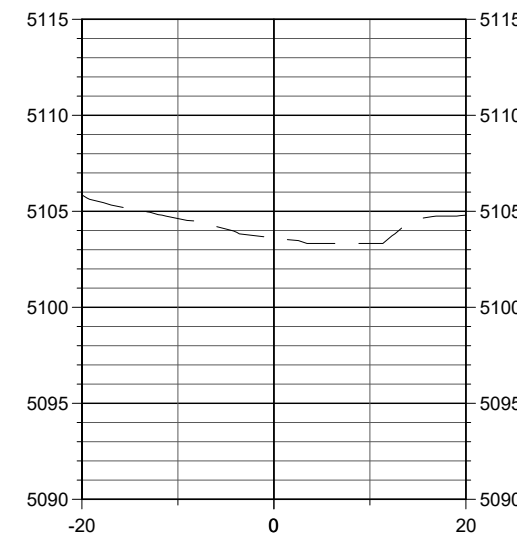

STA. 81+80